

1

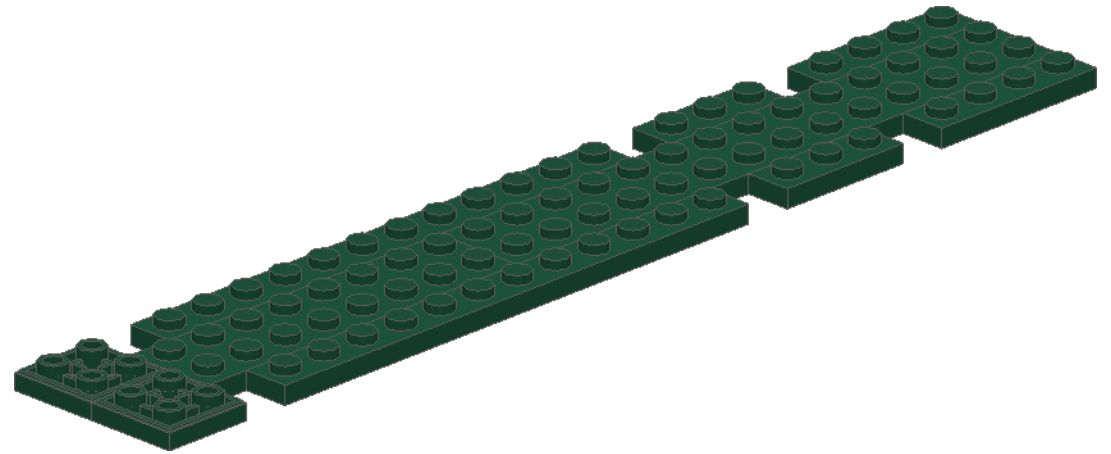

2

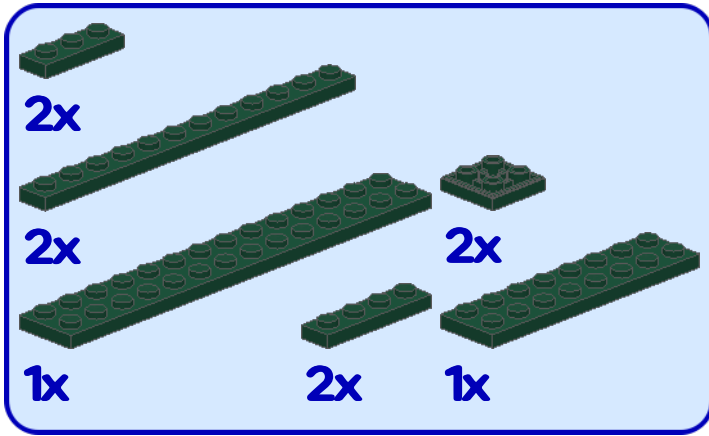
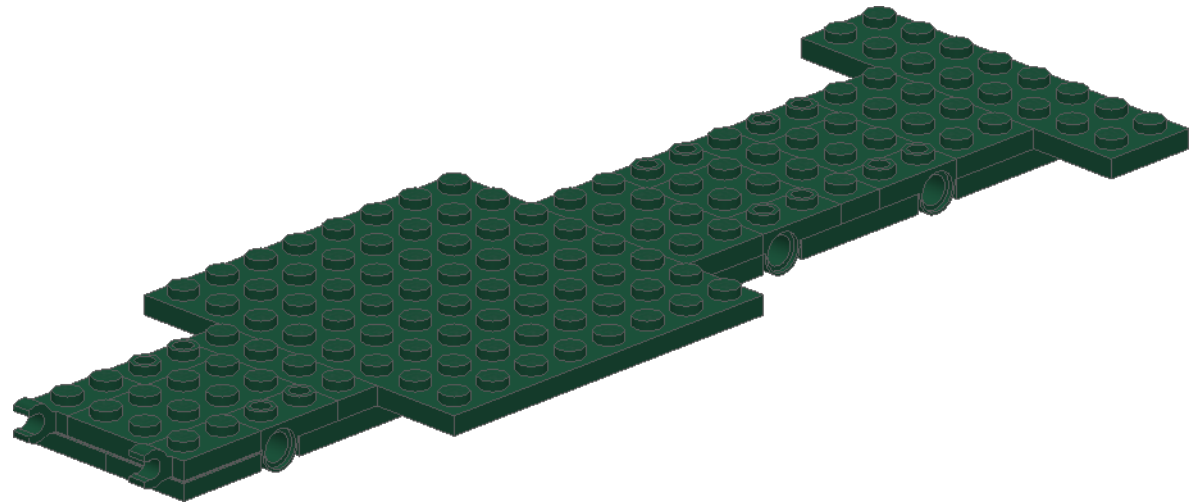
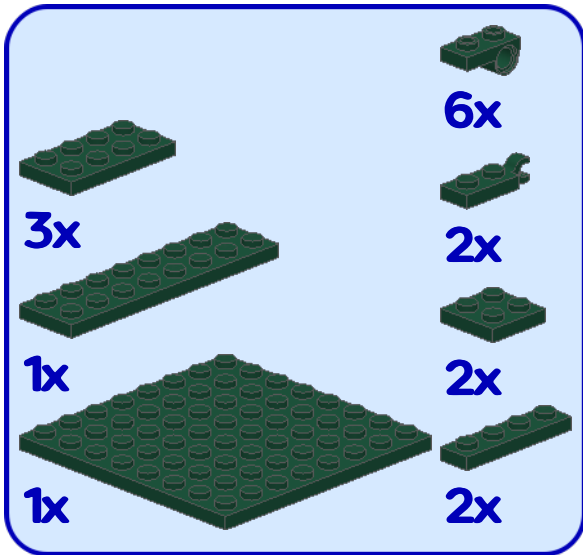

3

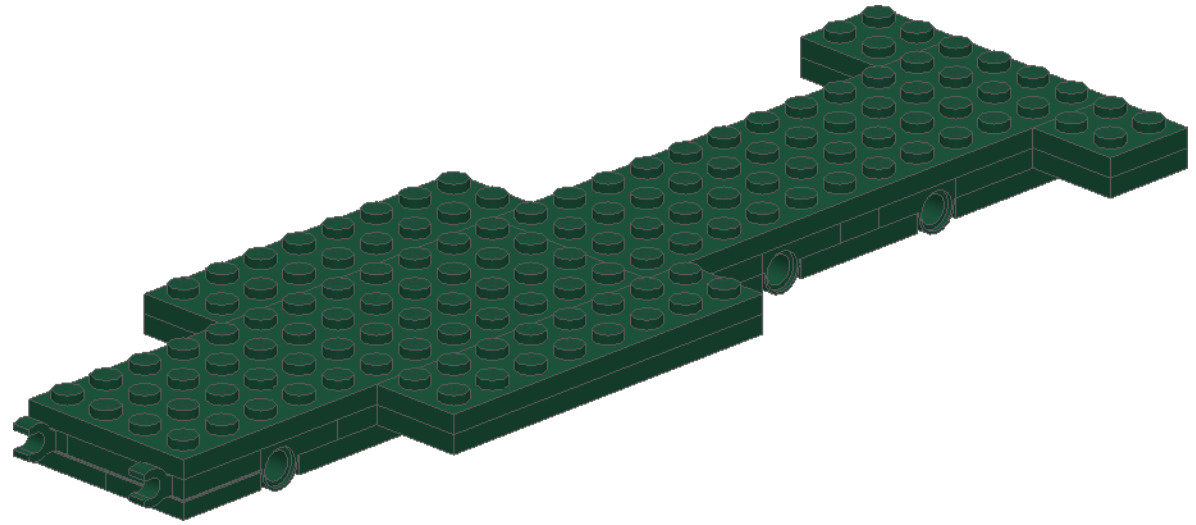
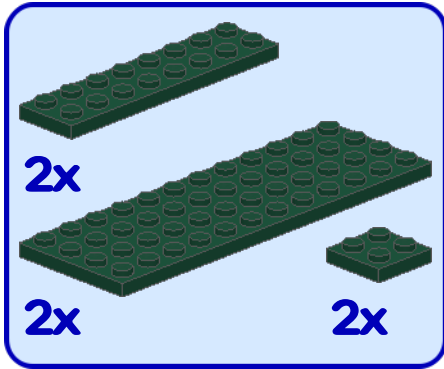

4

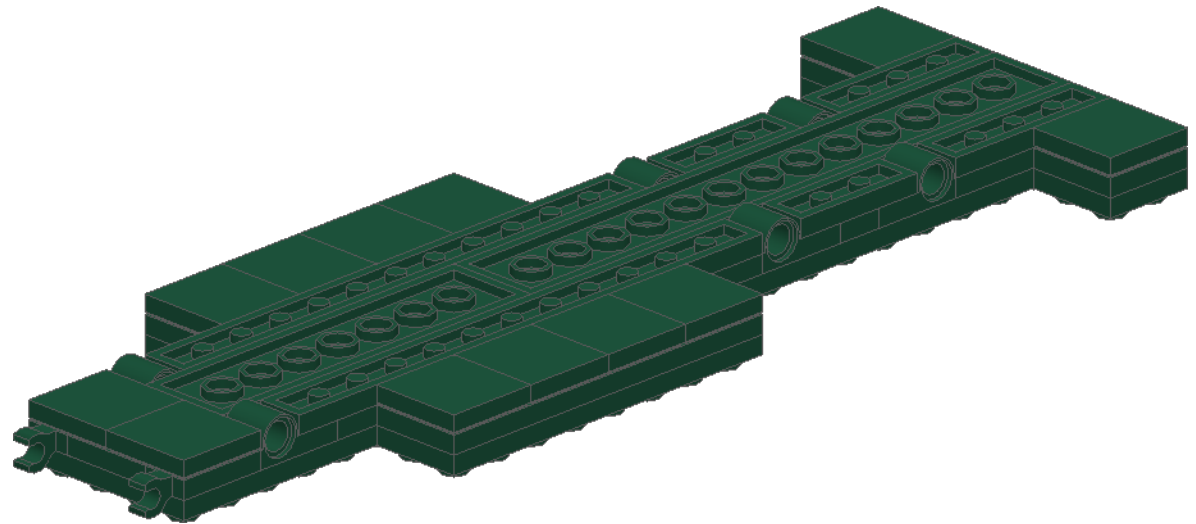

5

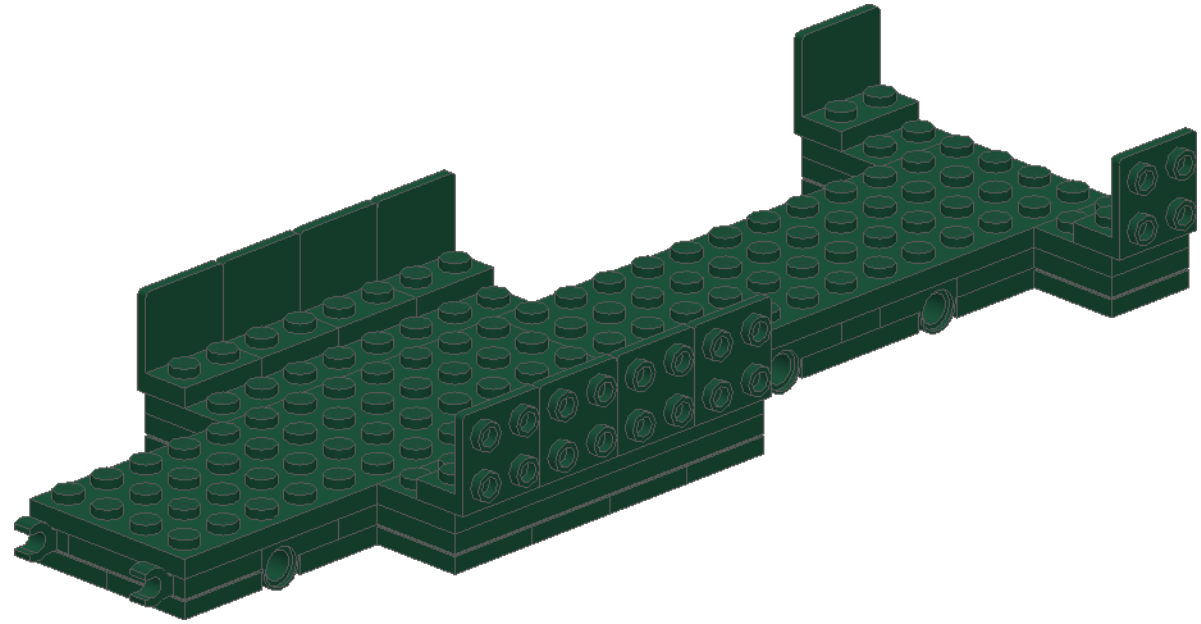

6

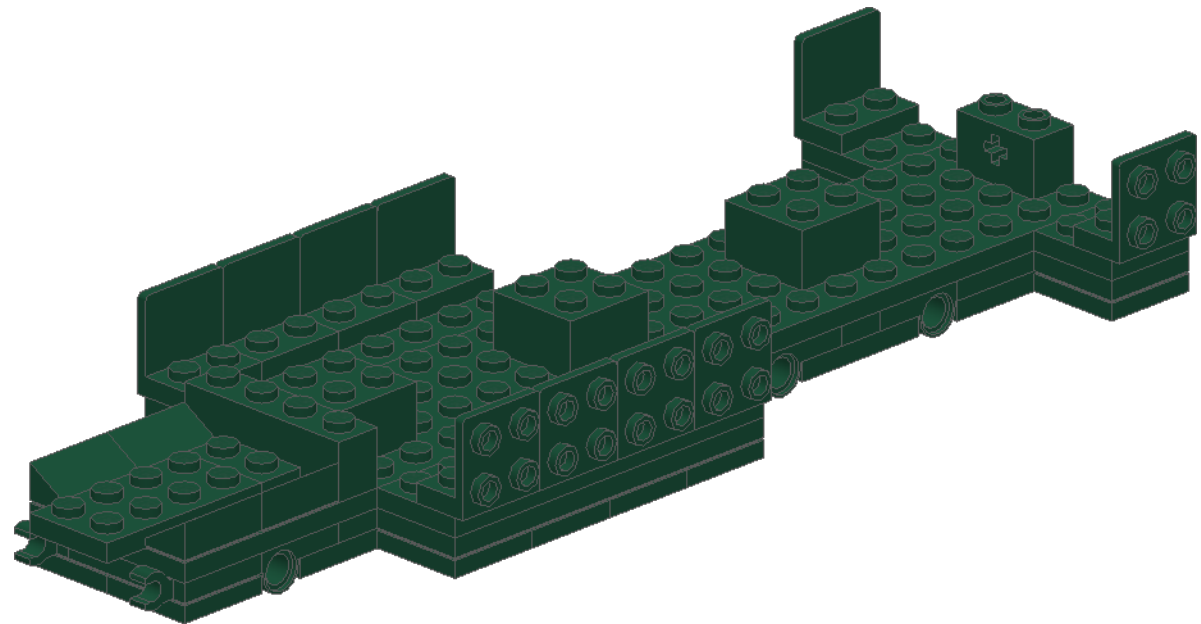
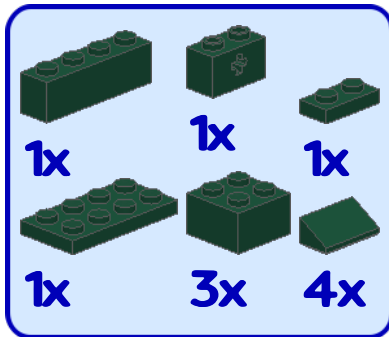

7

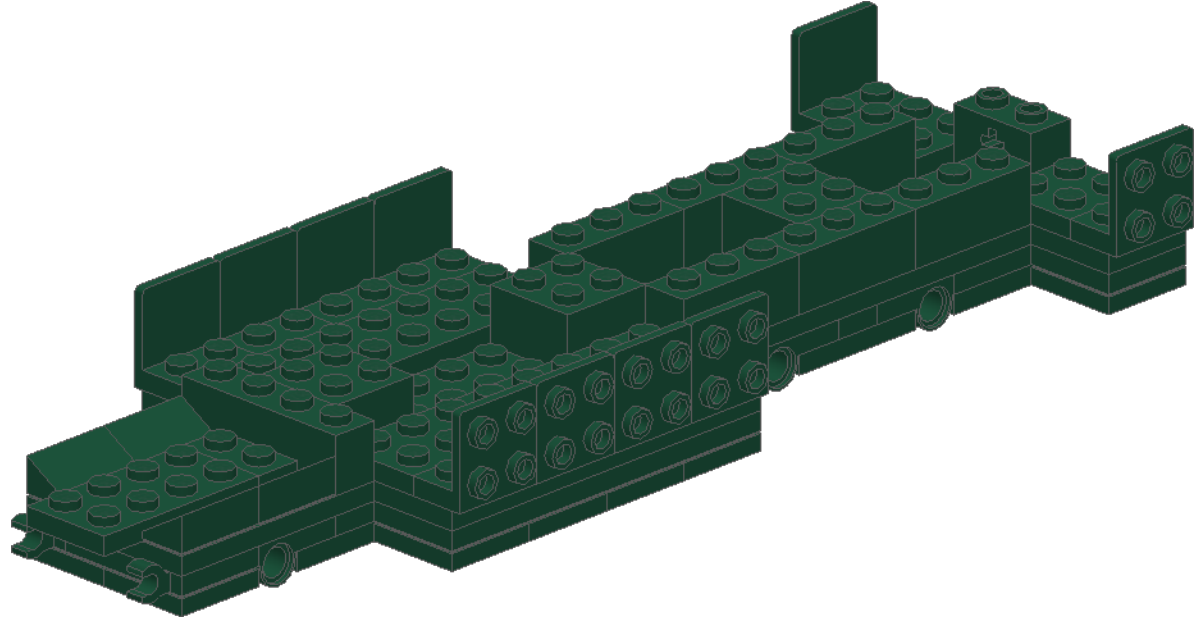
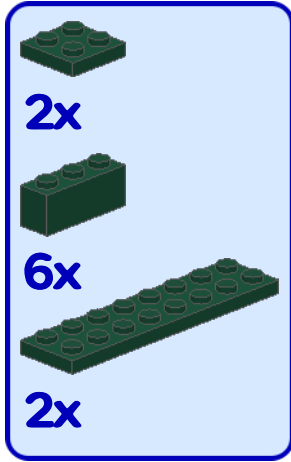

8

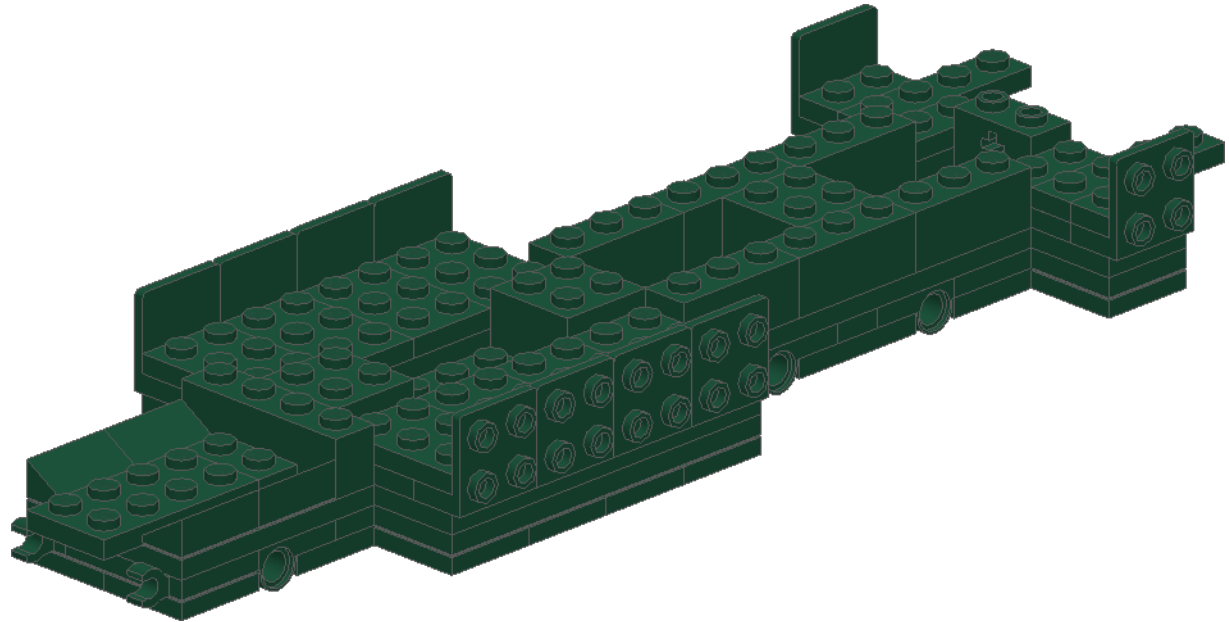
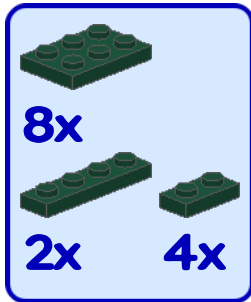

9

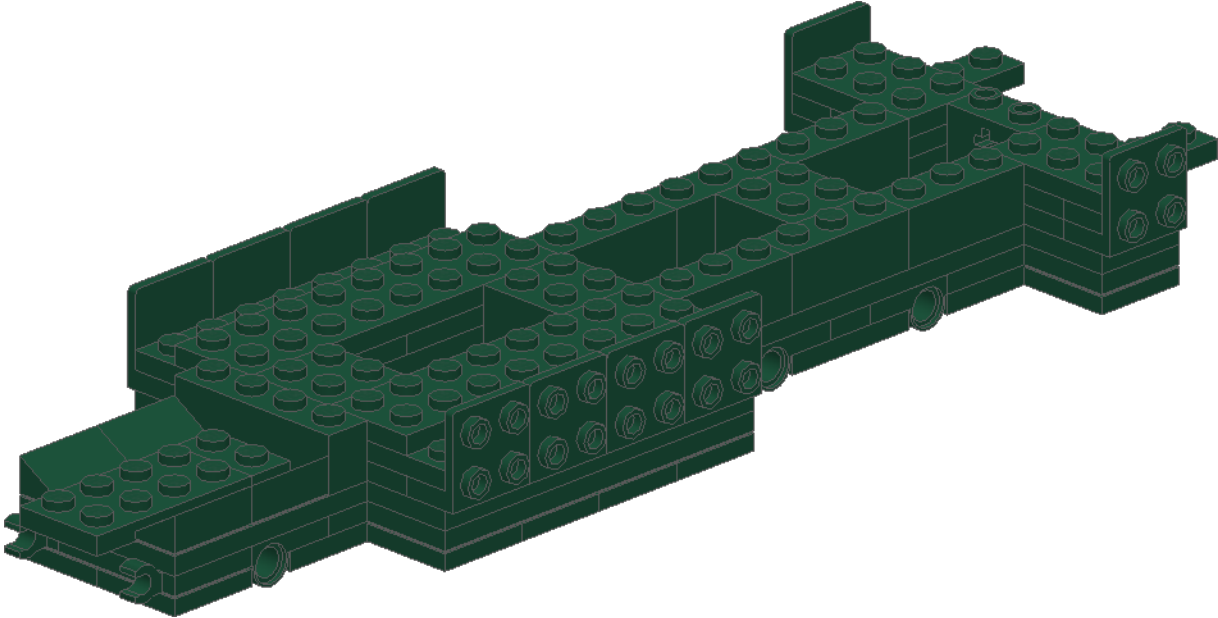
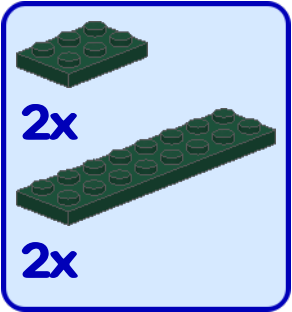

10

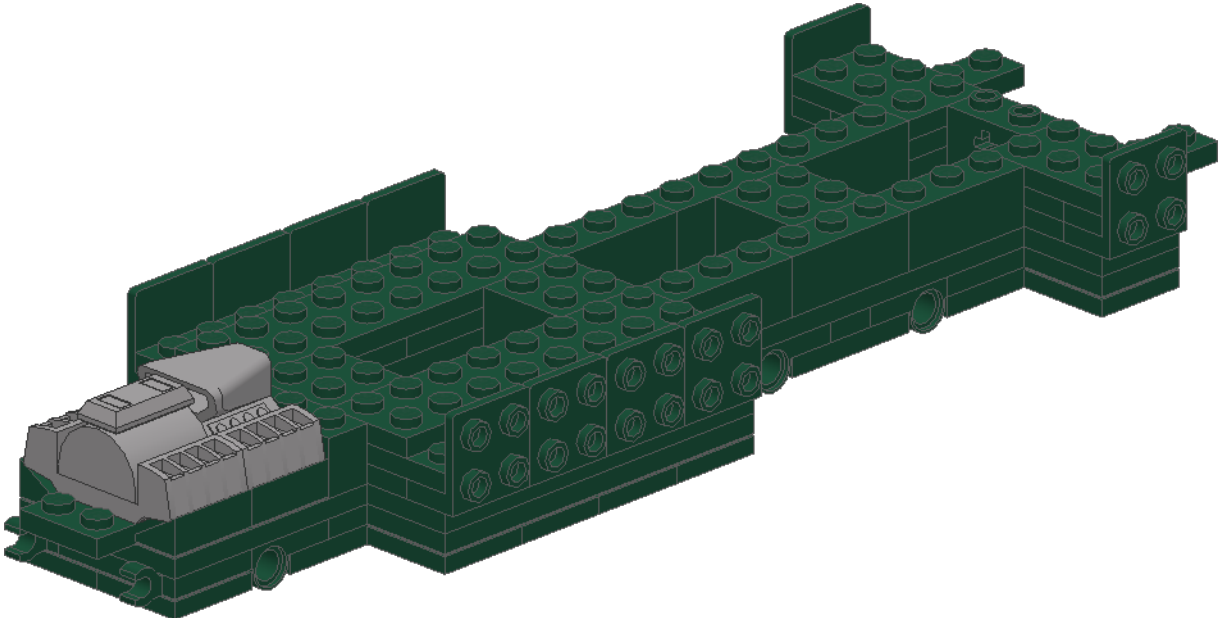
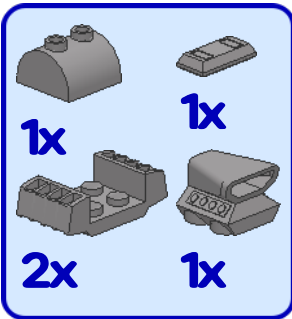

1

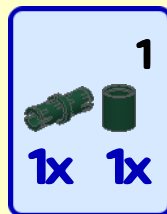

2

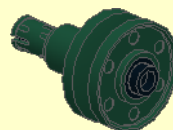
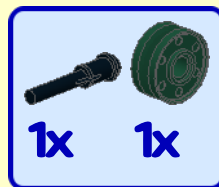

3

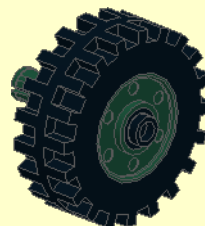

11

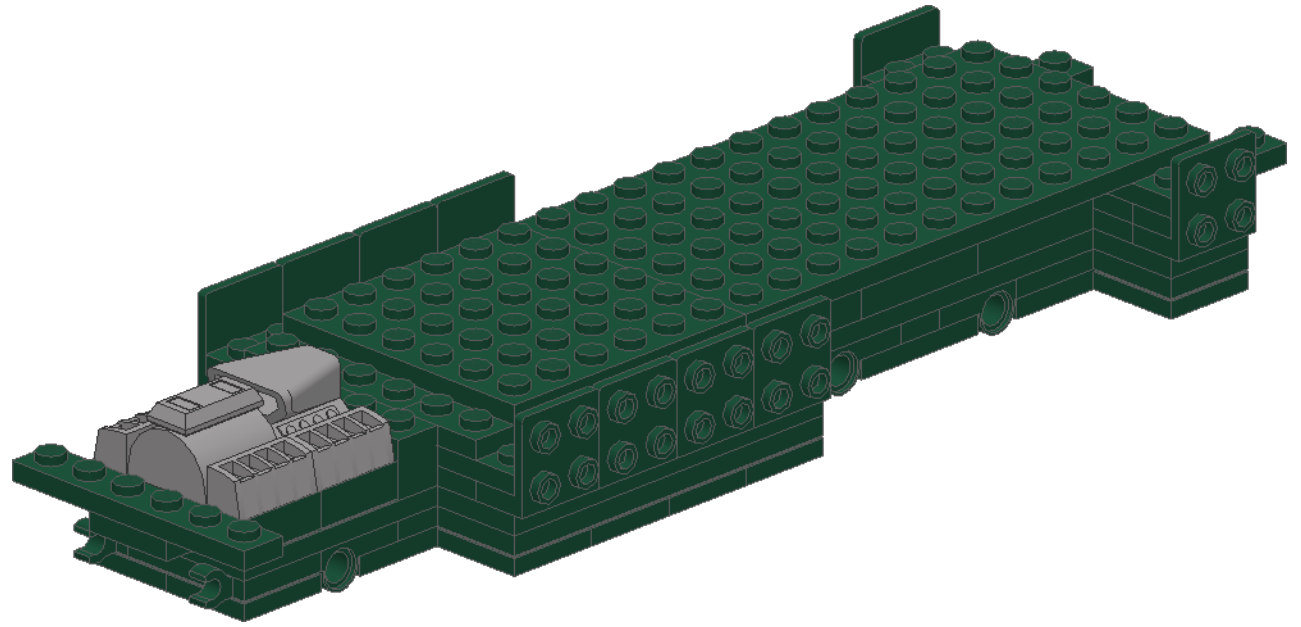
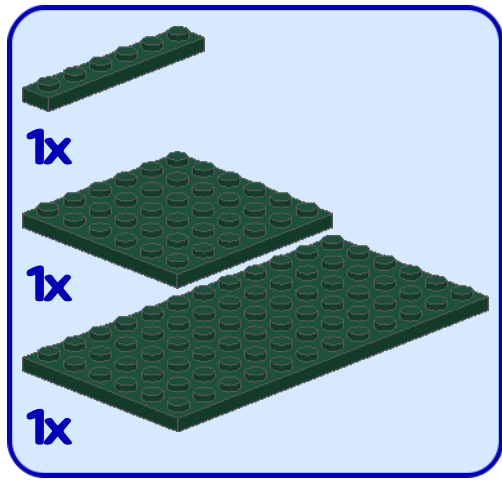

12

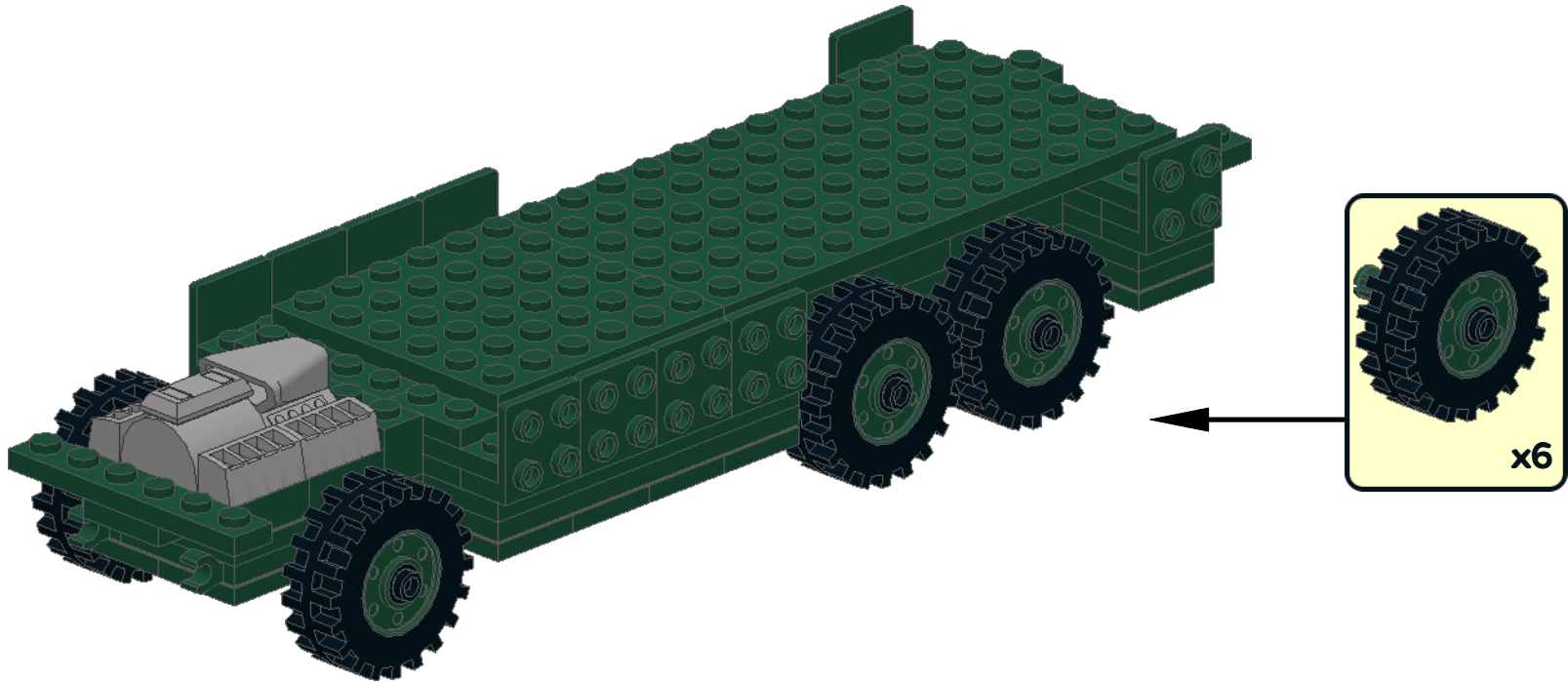



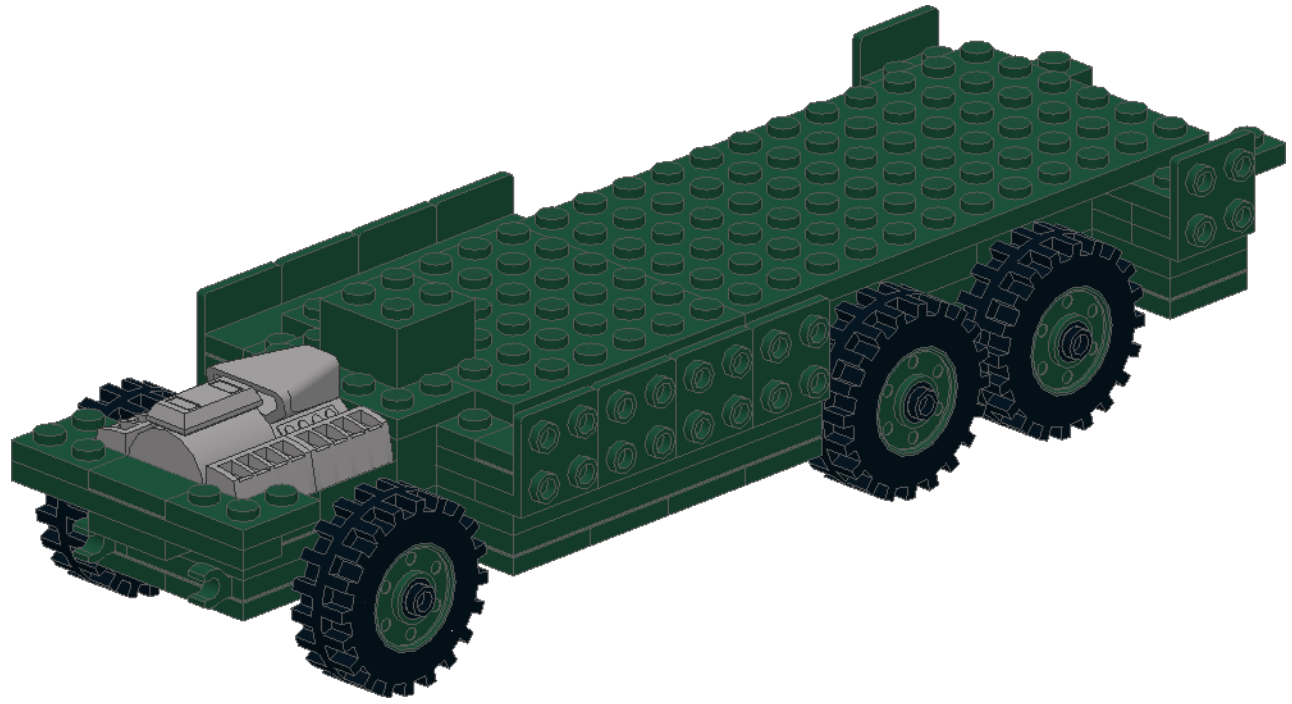
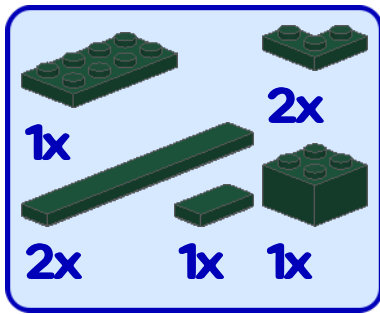

13

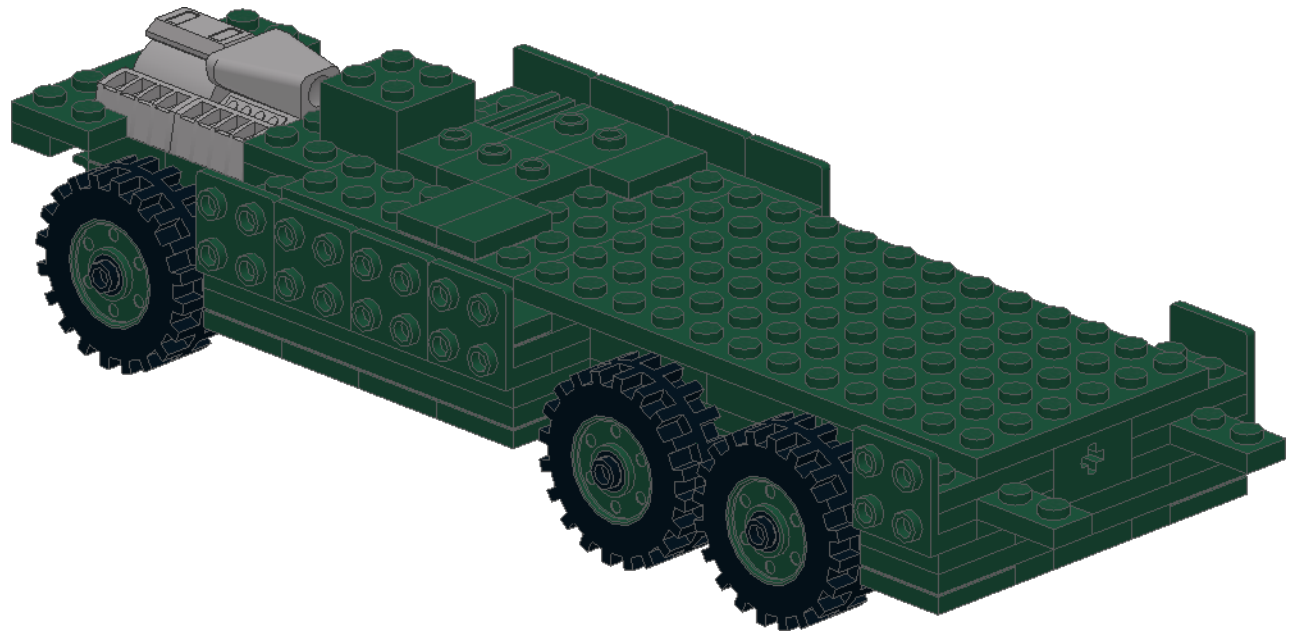
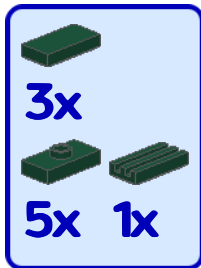

14



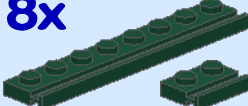



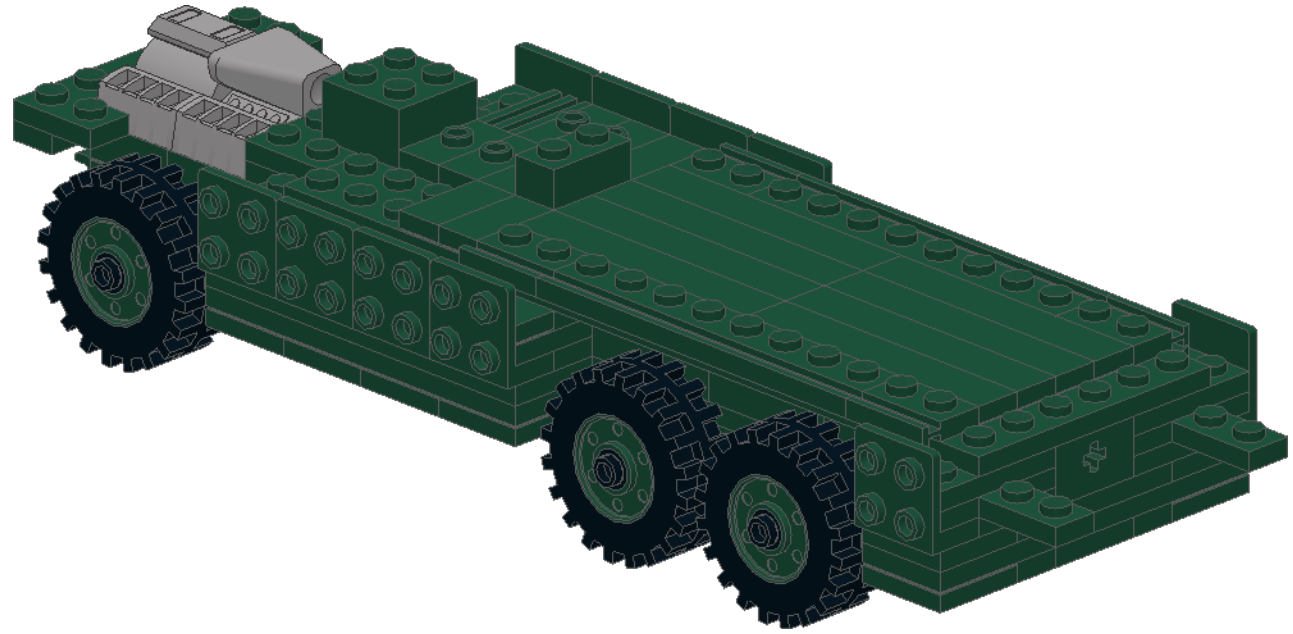

15

	1x
	8x
	2x
	4x







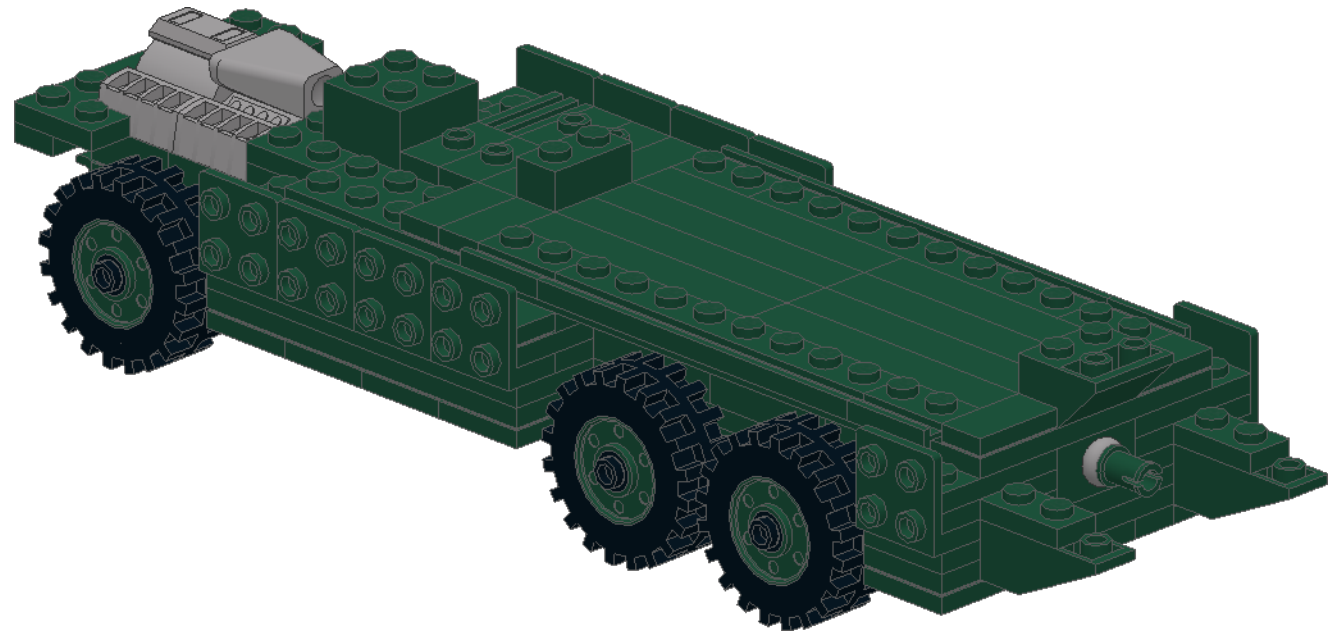

16

	1x
	2x
	1x
	1x
	2x
	



19

		
8x	2x	2x
		
2x	6x	2x

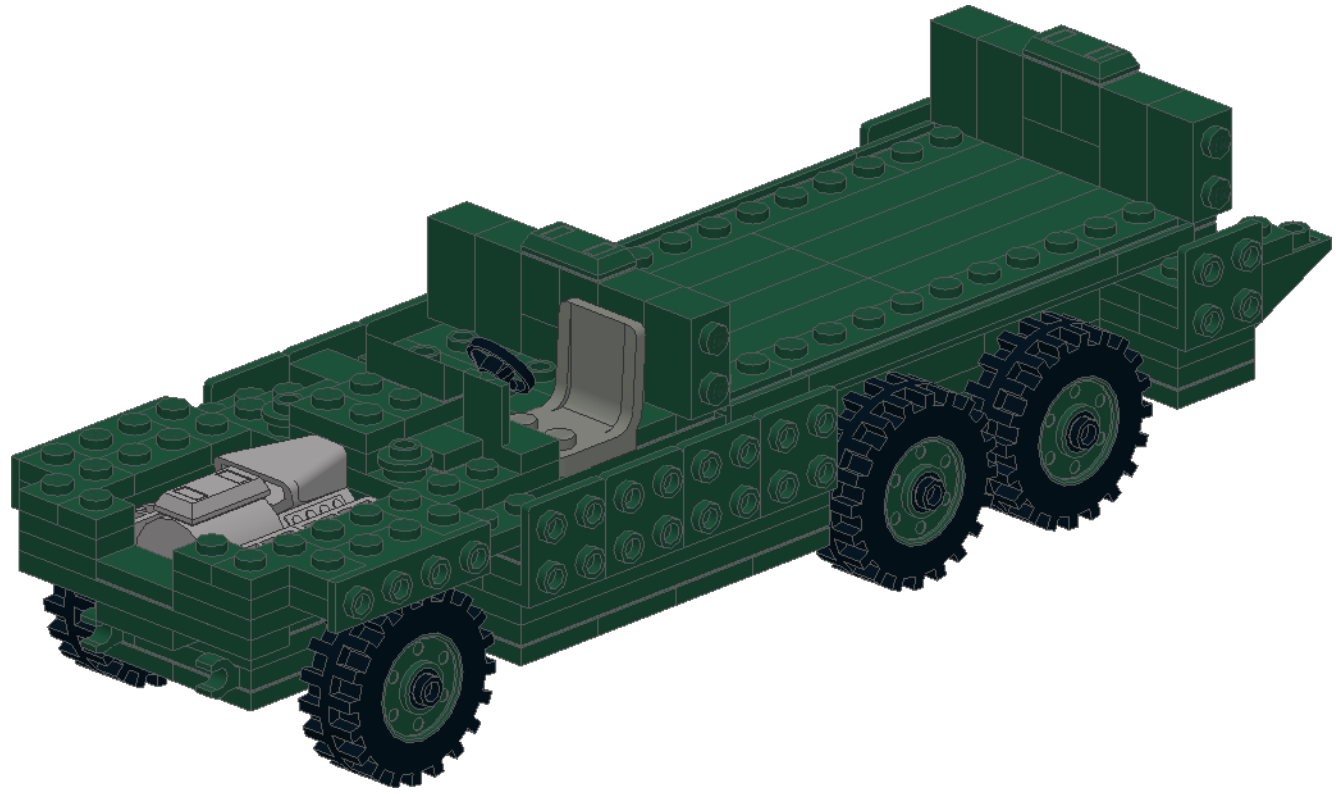

20

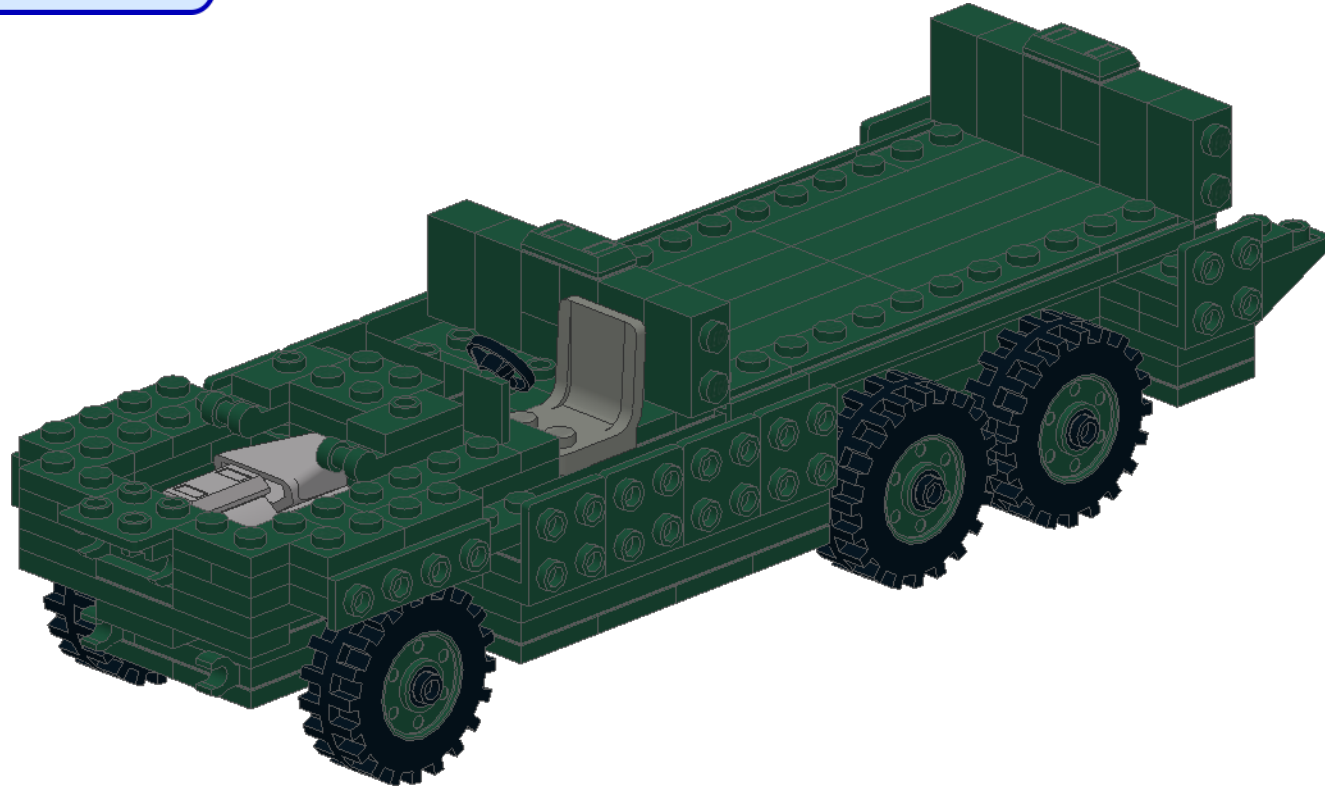
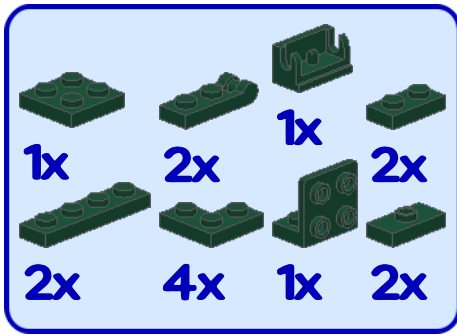

21

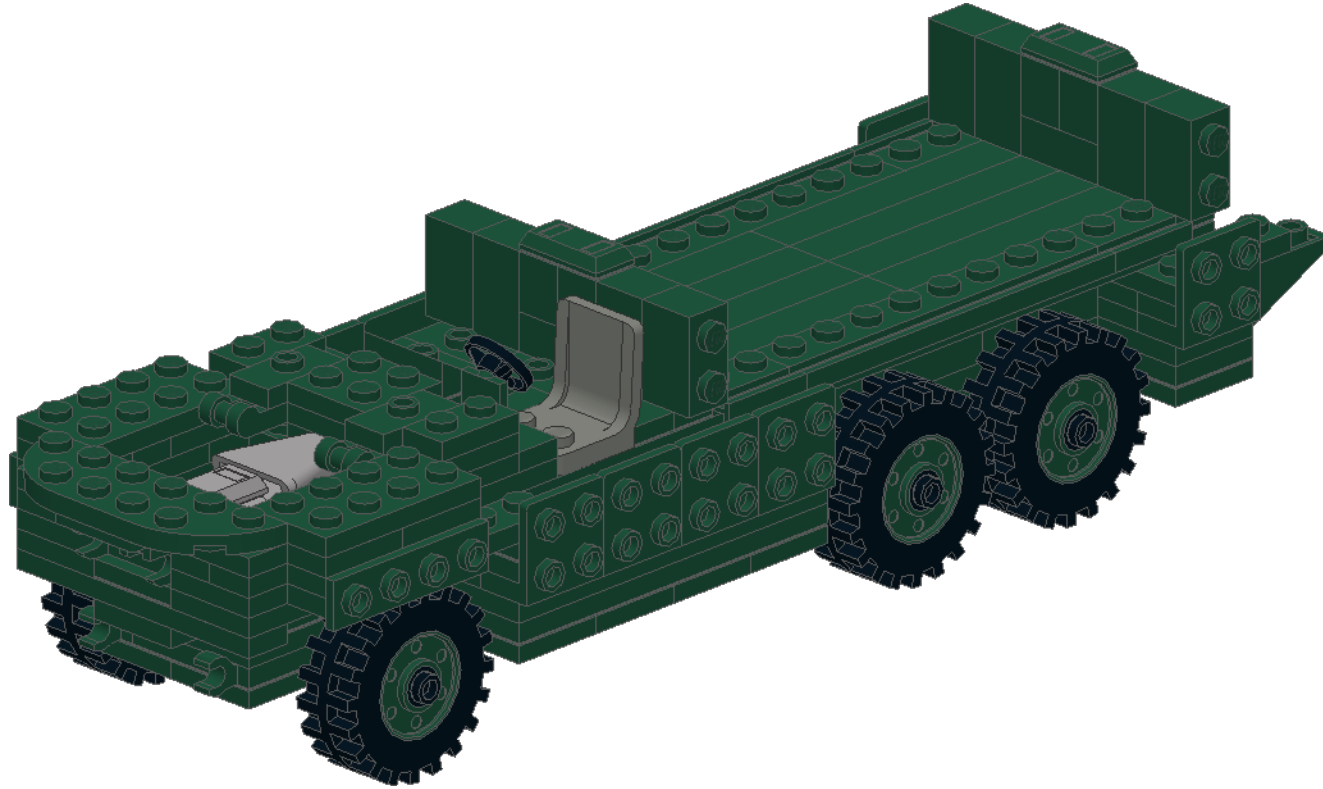
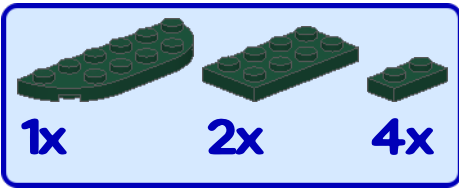

22

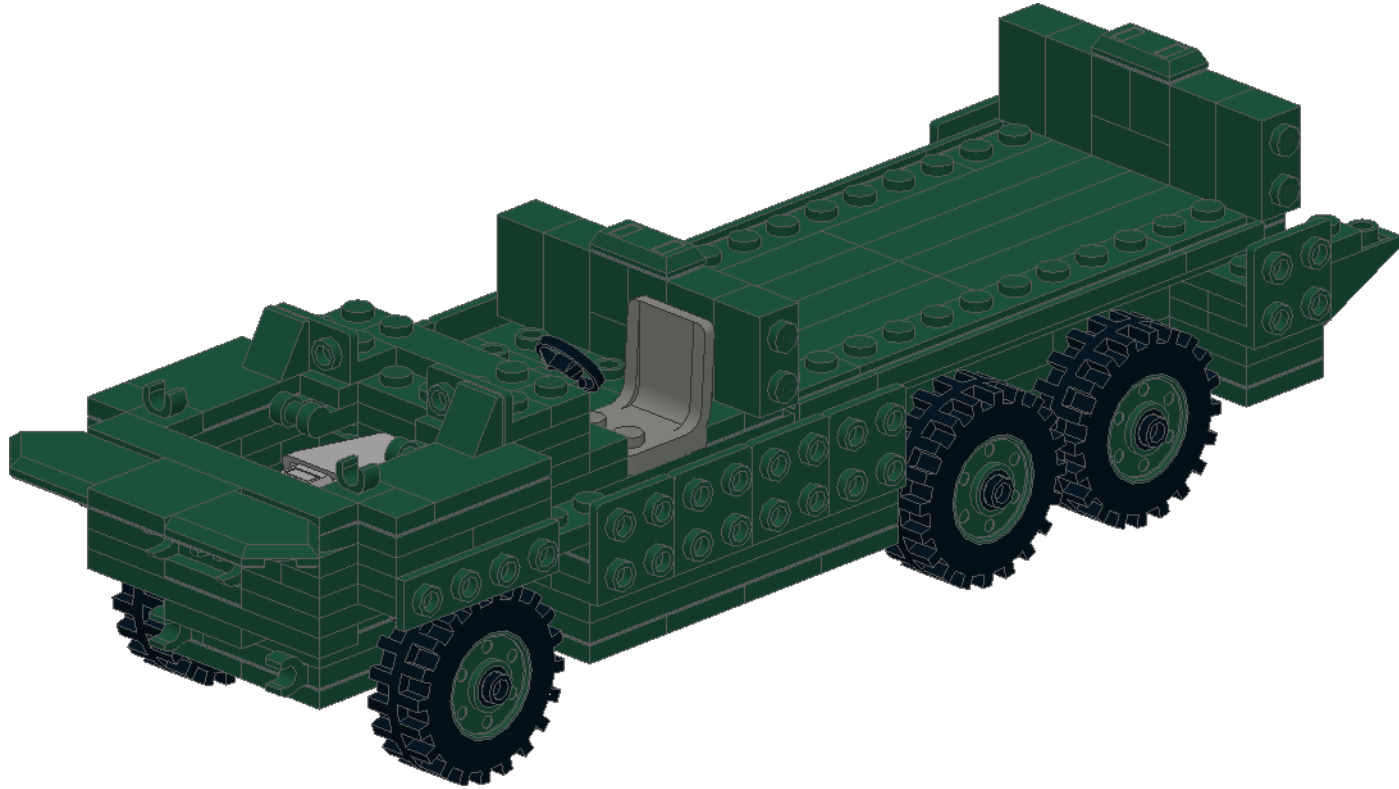
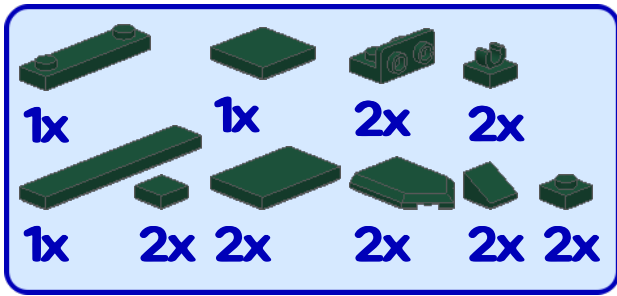

23

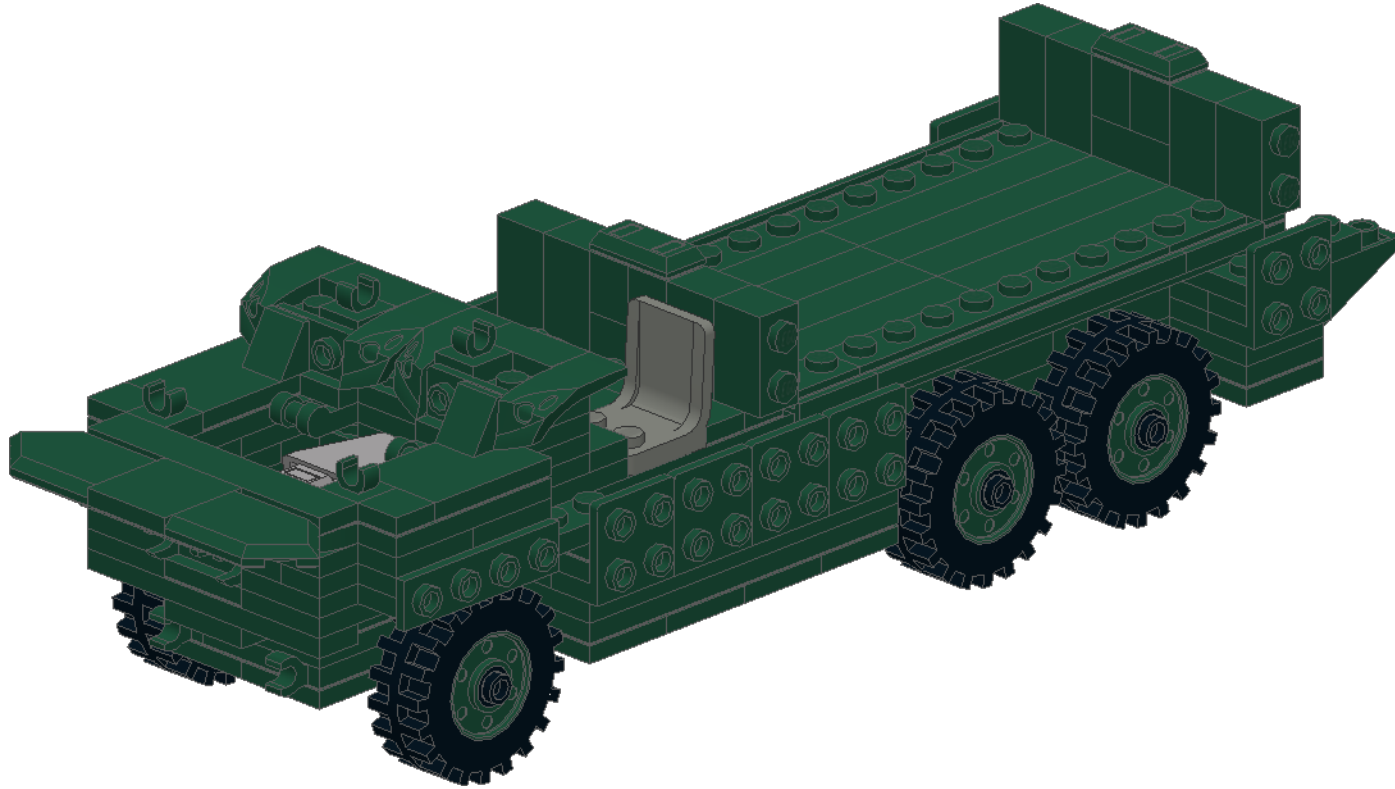
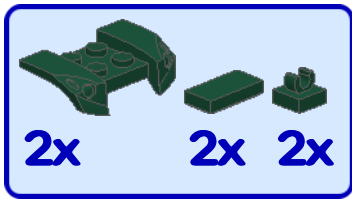

1

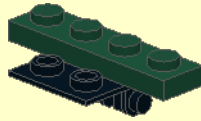
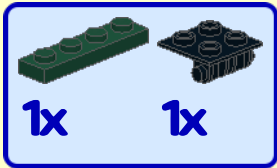

2

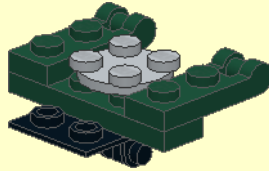
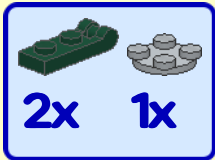

3

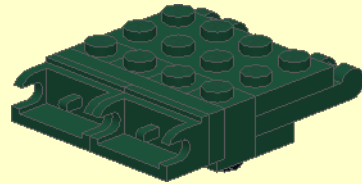
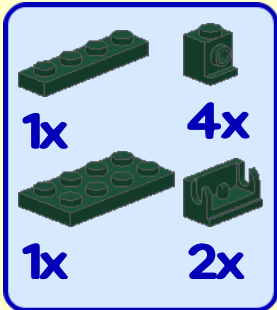

4

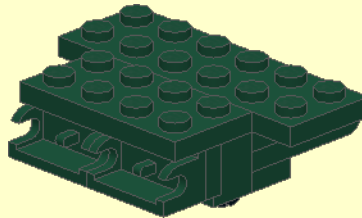
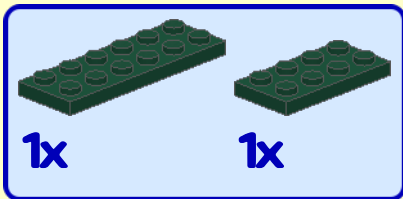

5

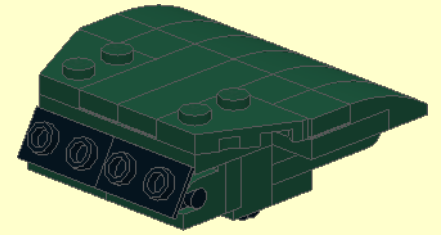
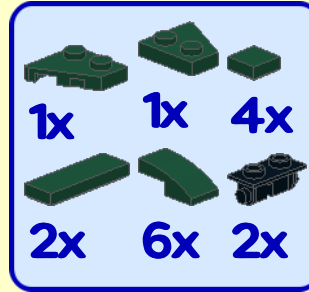

6

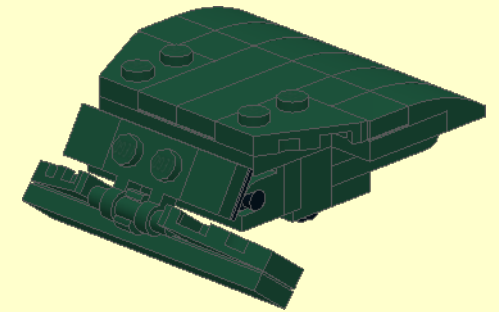
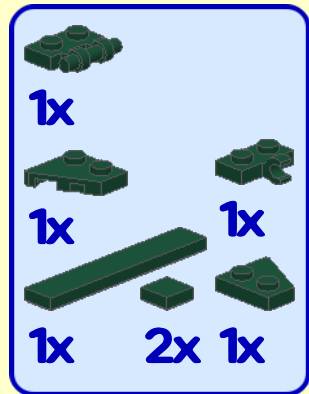

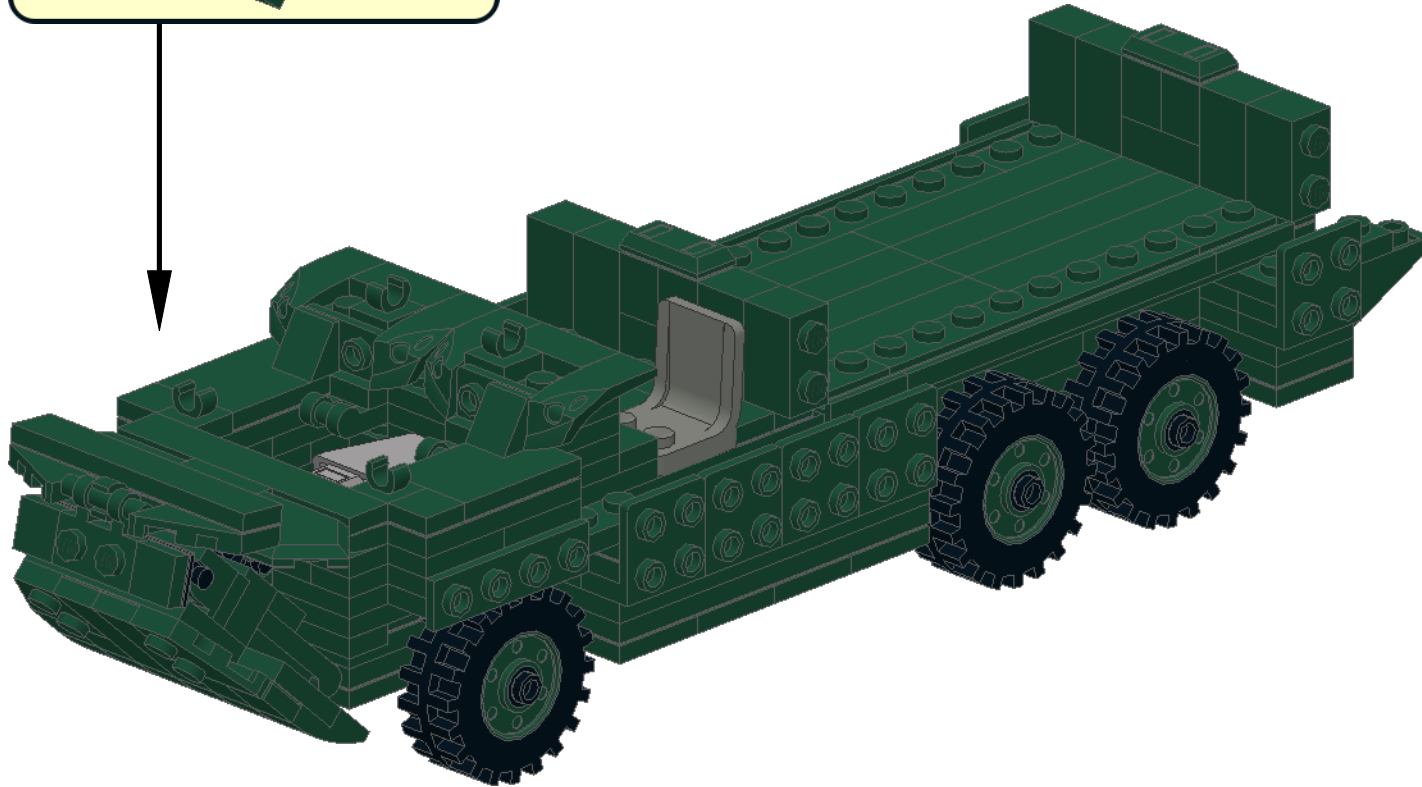
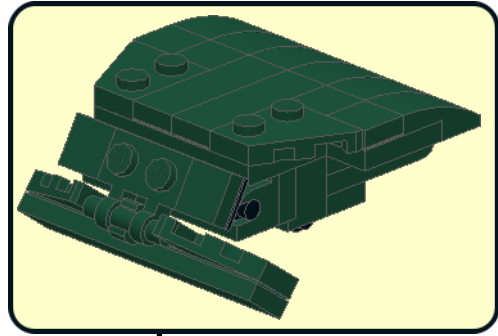

25

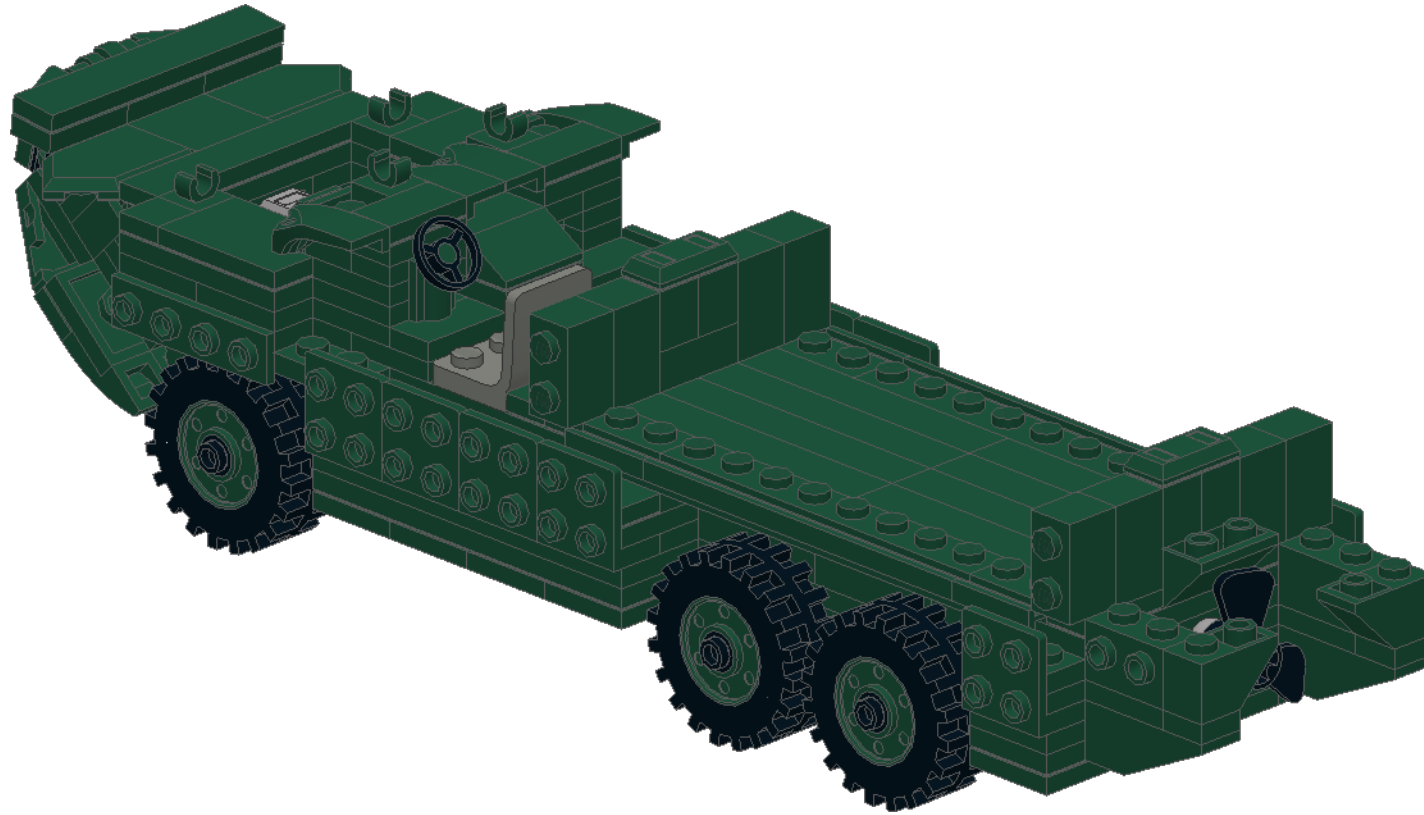
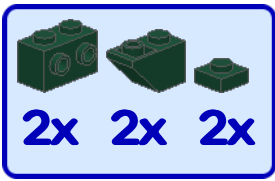

26

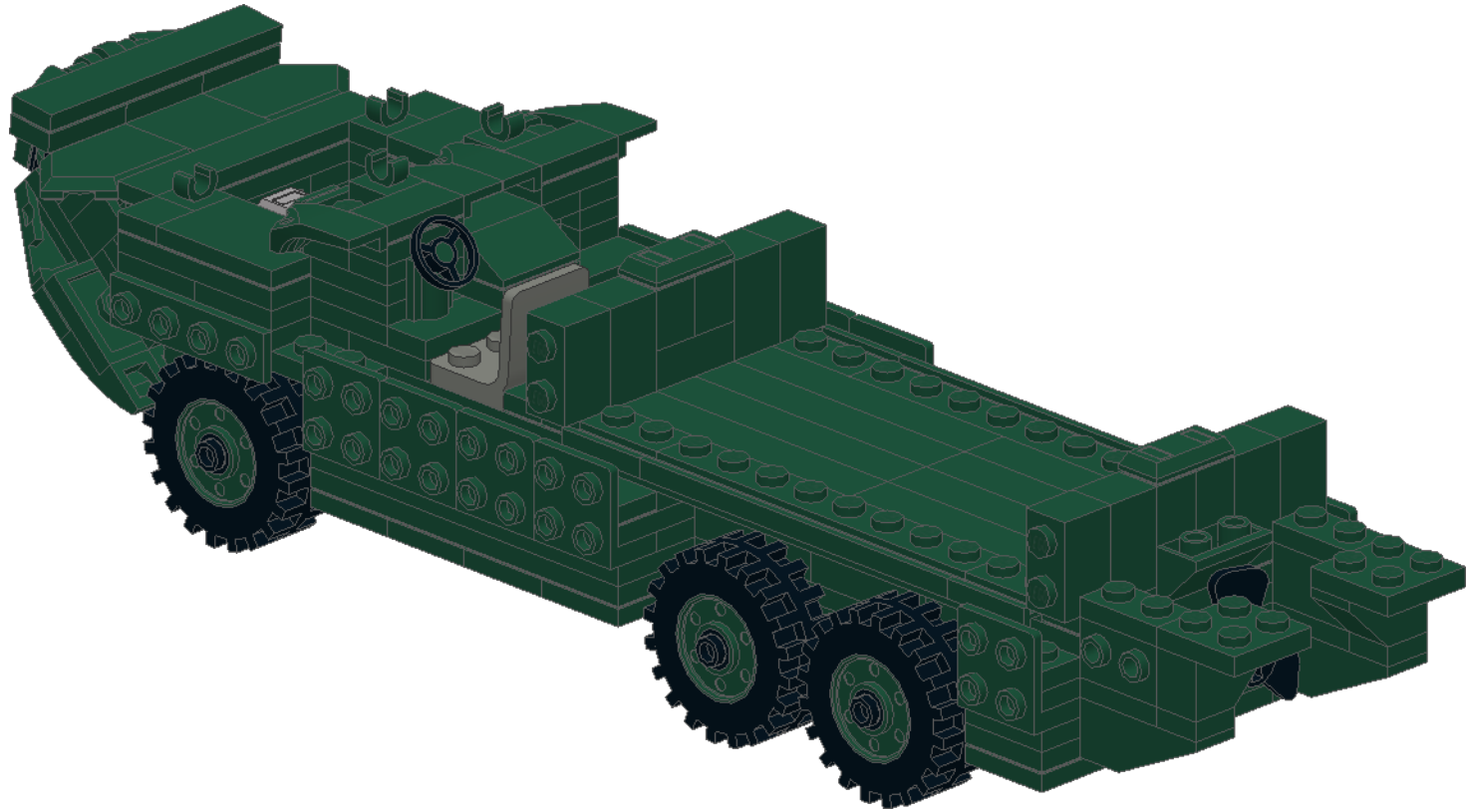
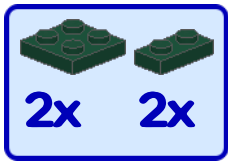

27

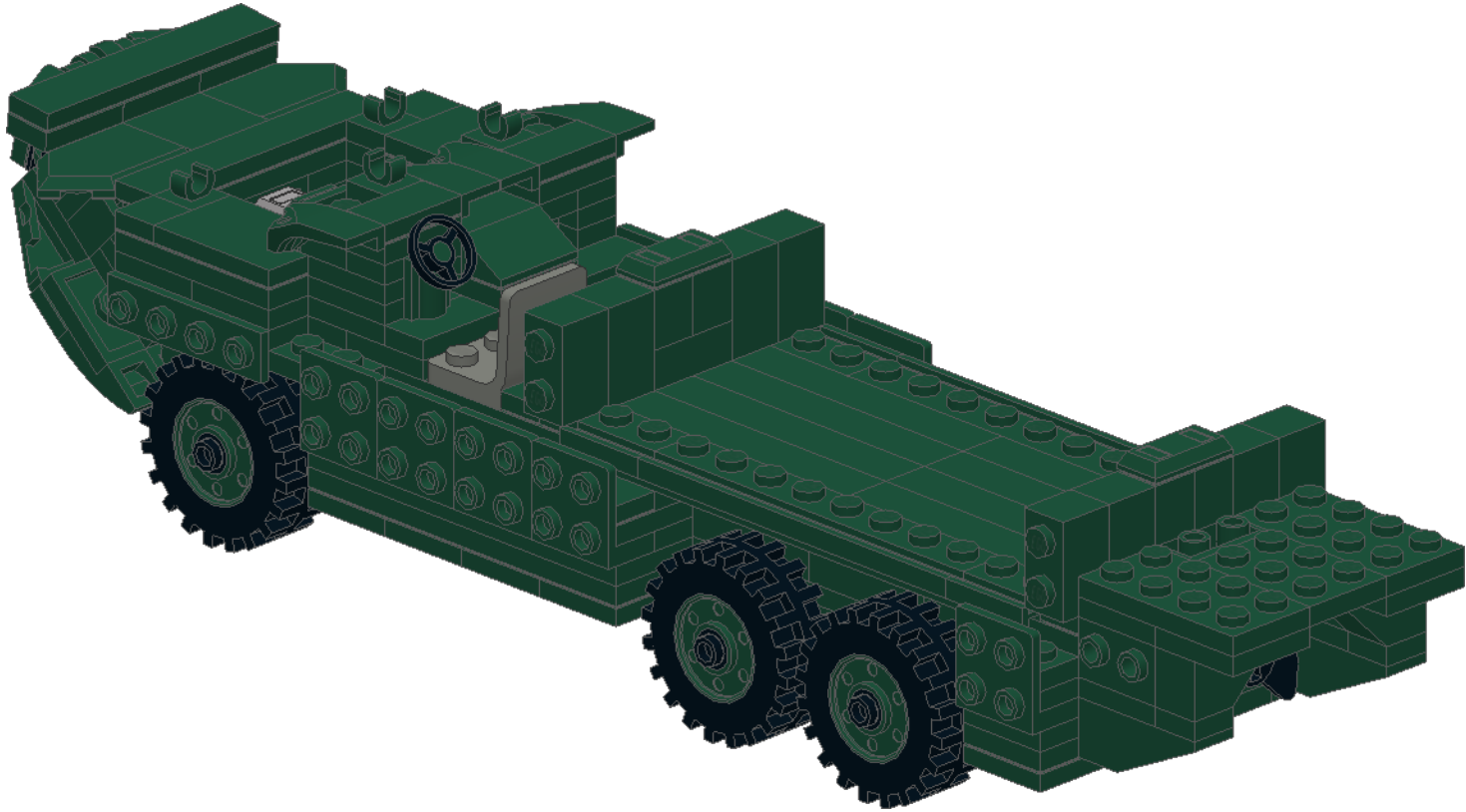
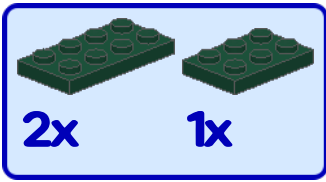

28

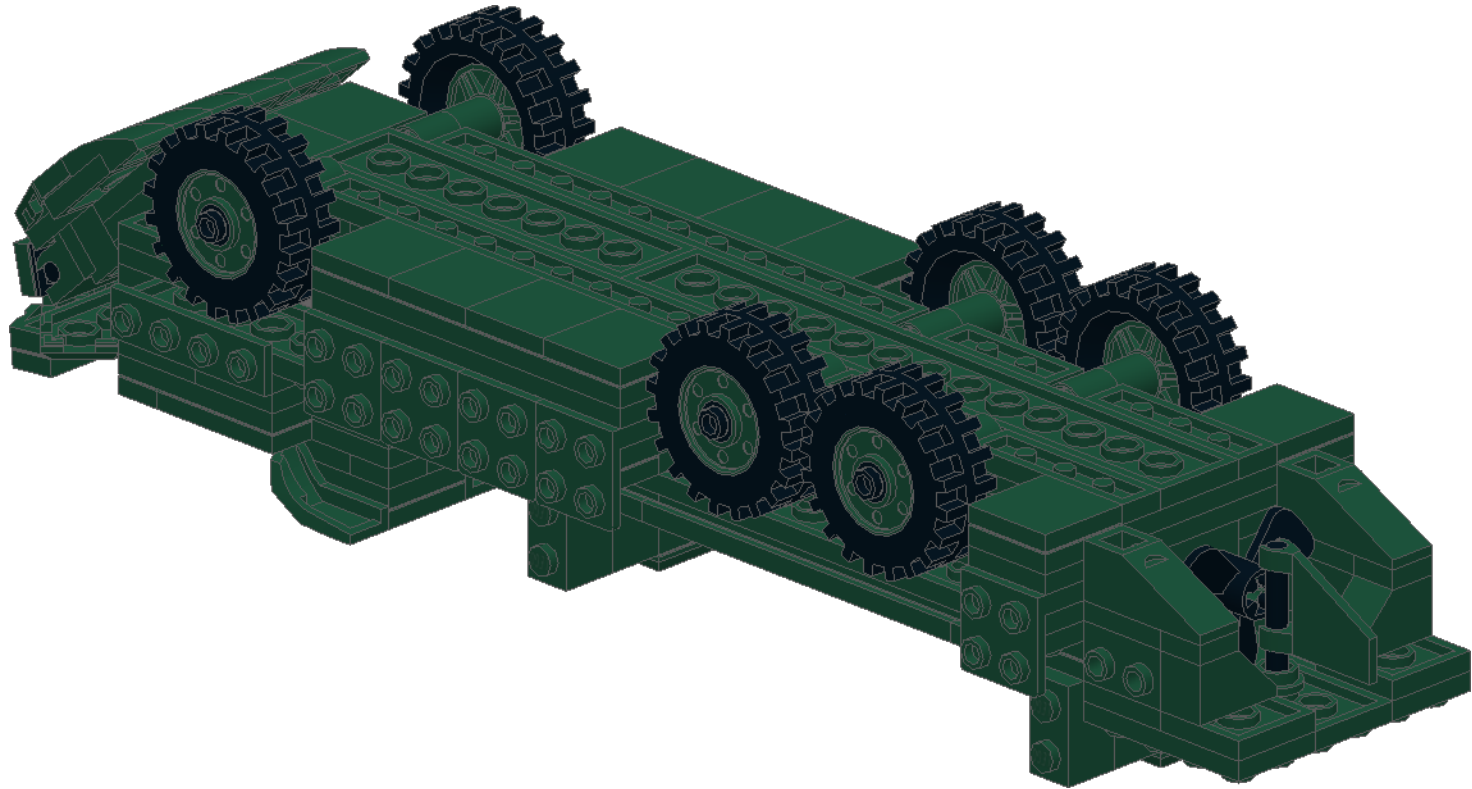
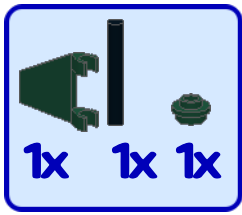

29

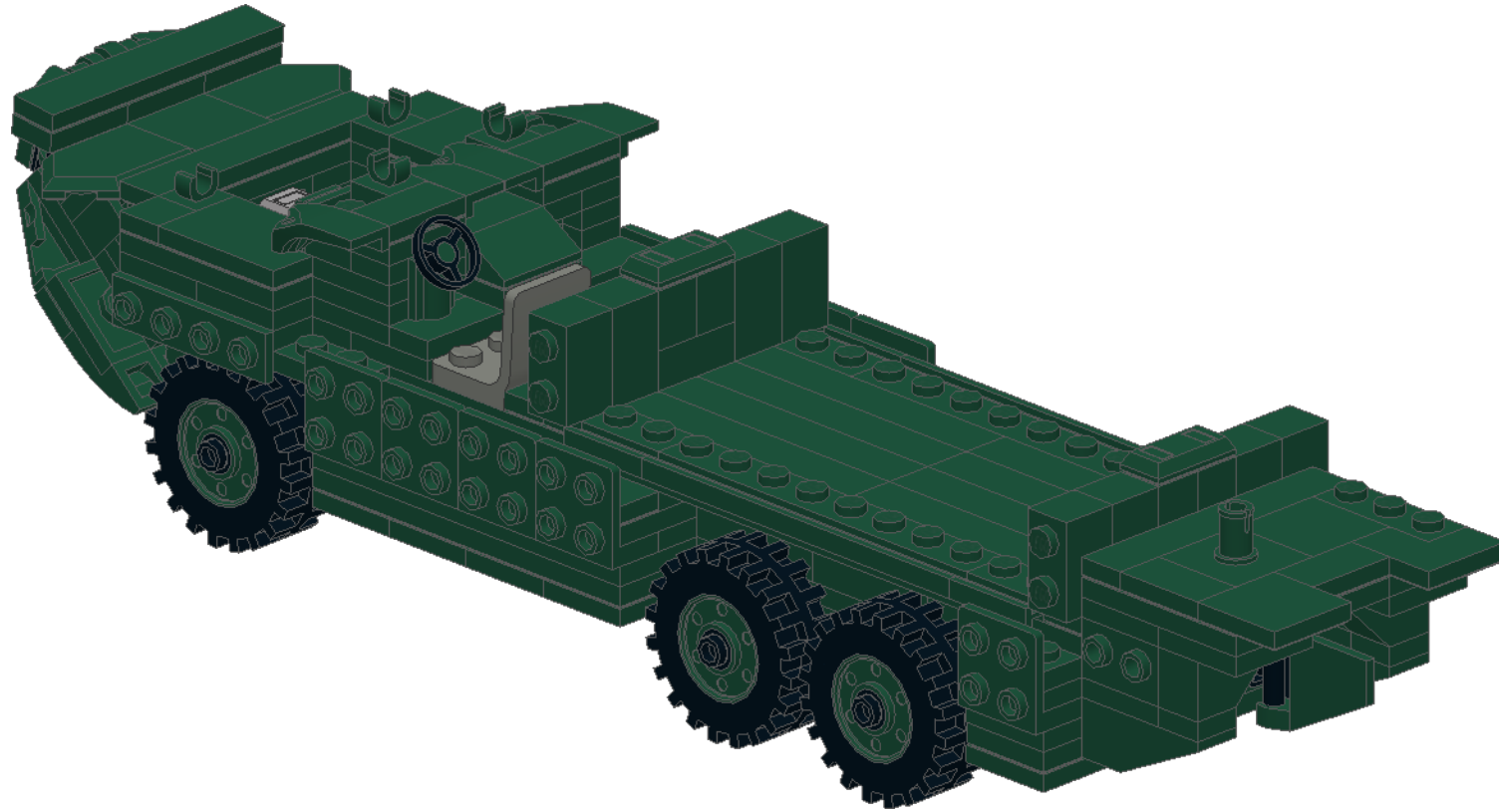
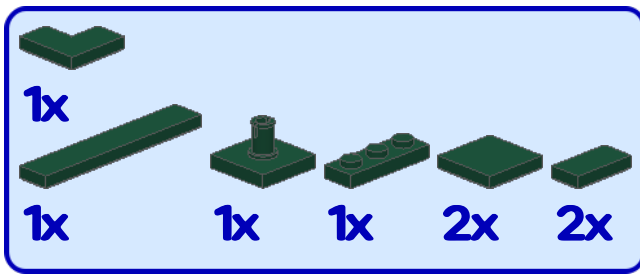

30

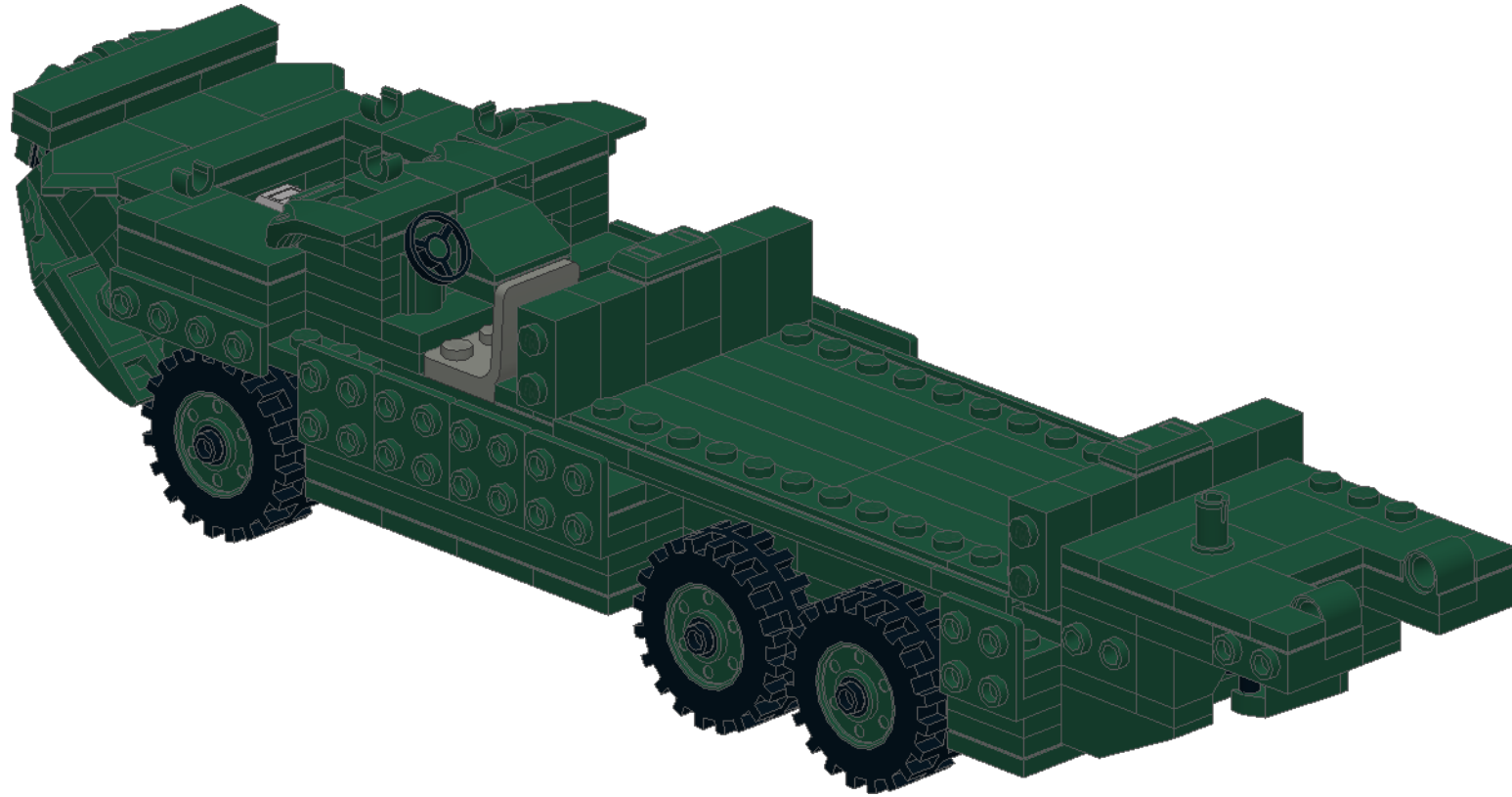
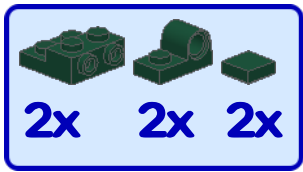

31

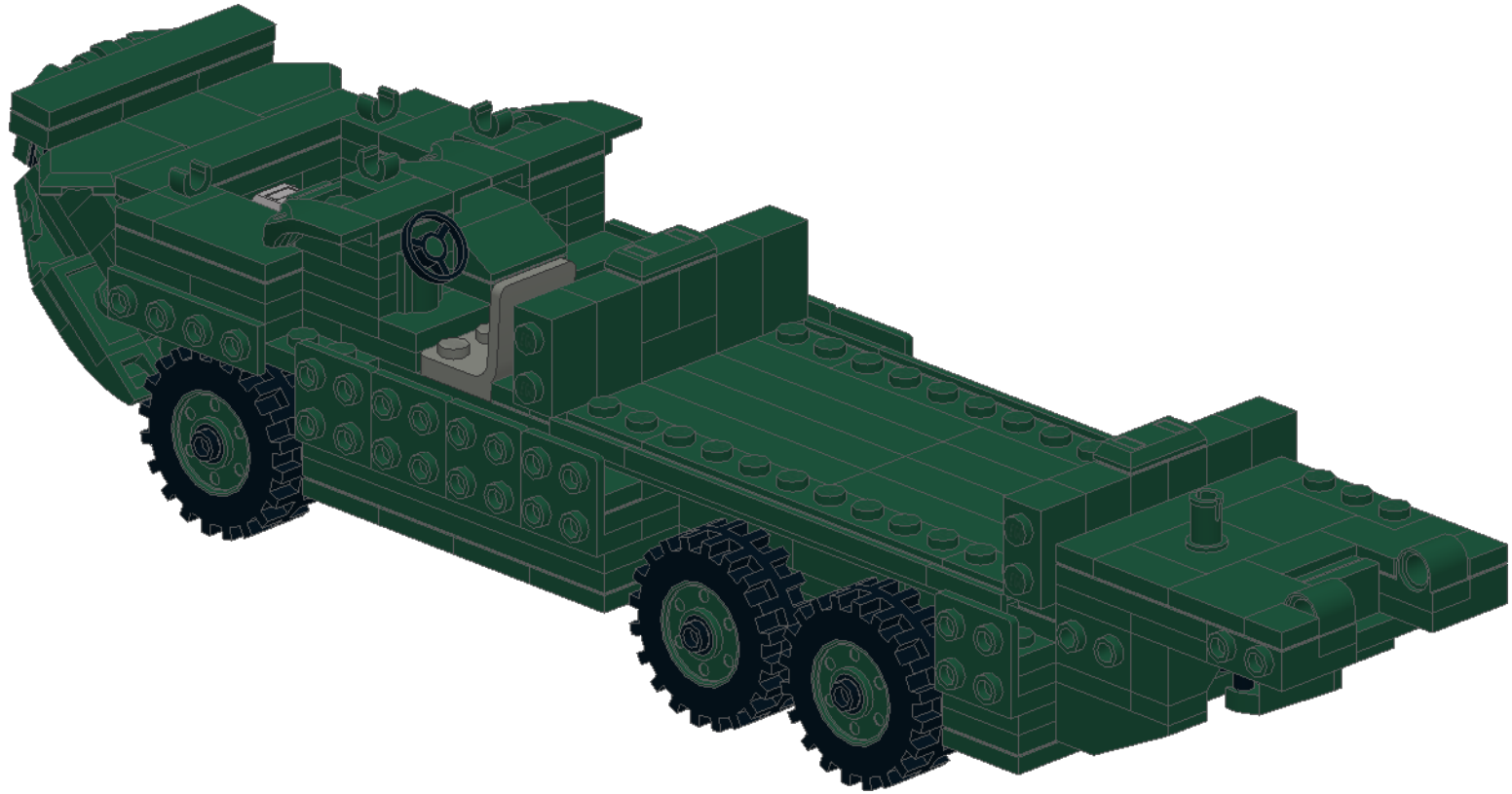
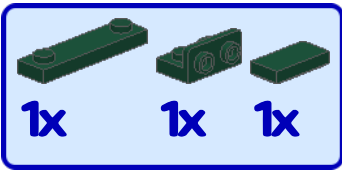

32

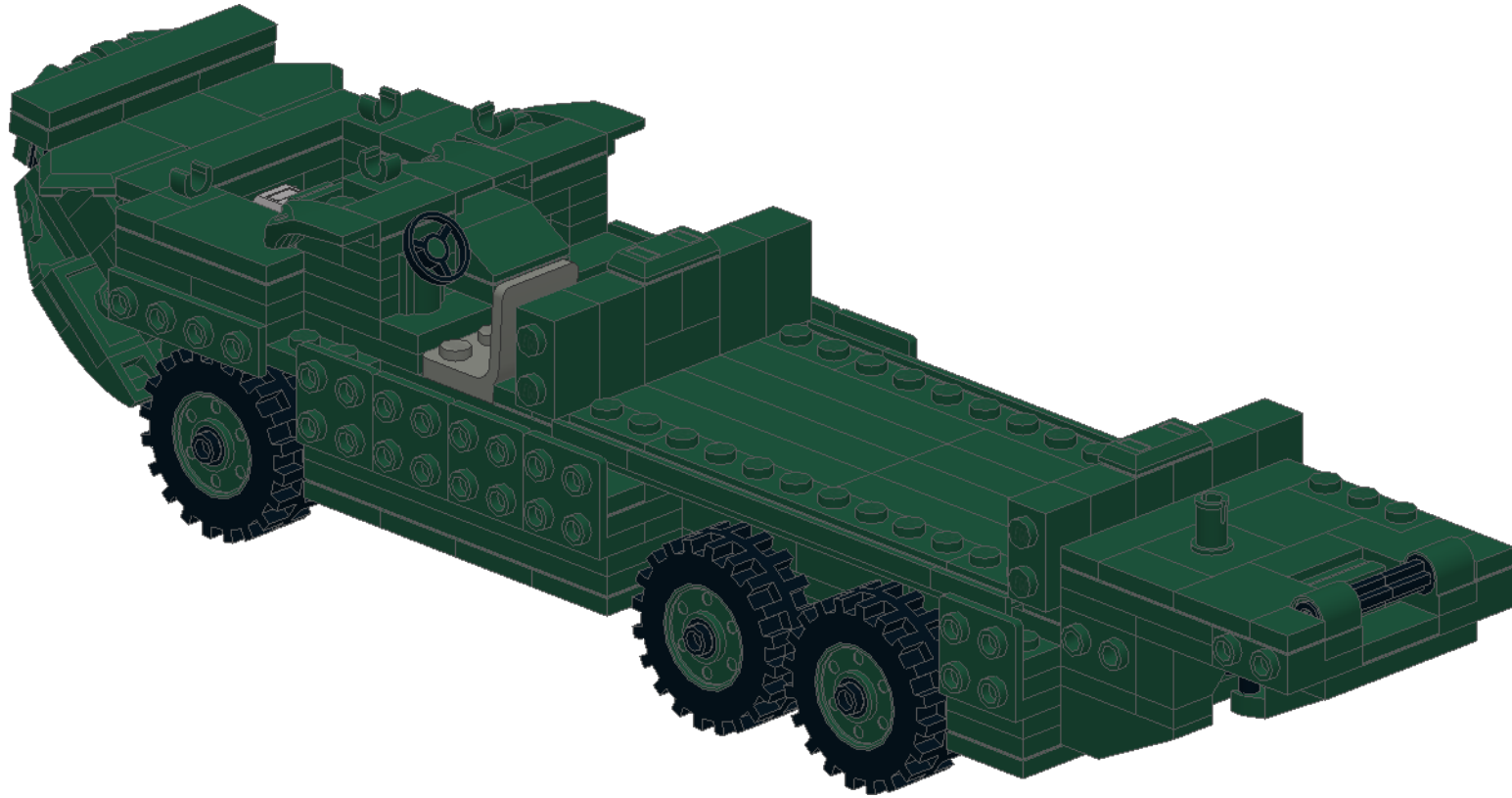
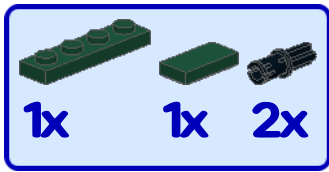

33

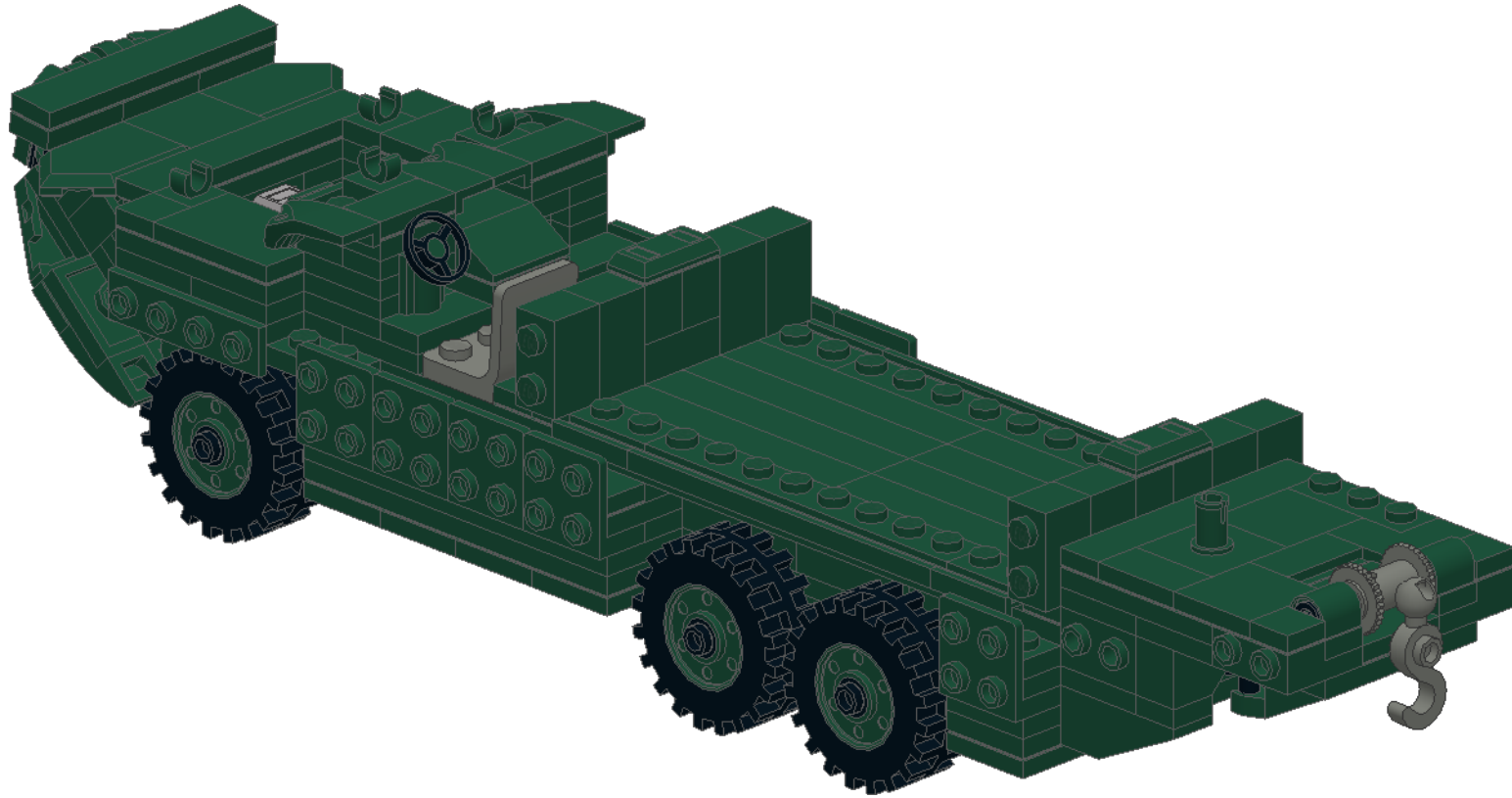
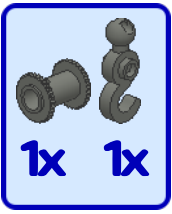

3

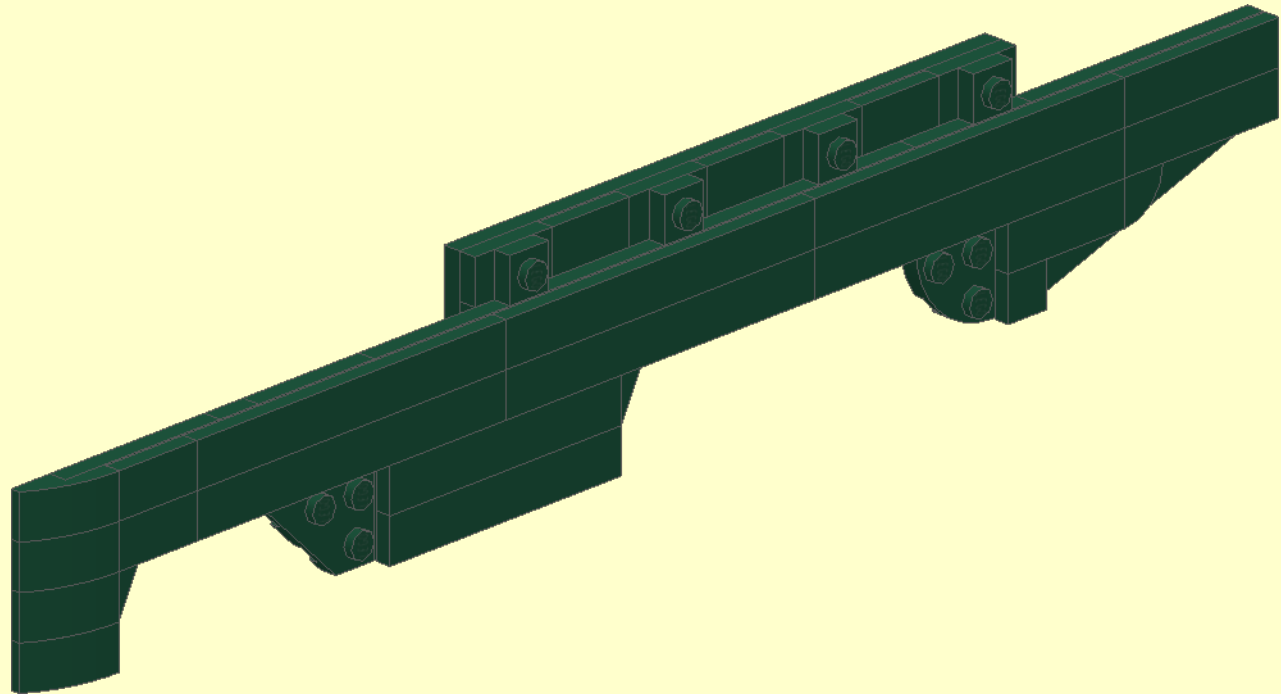
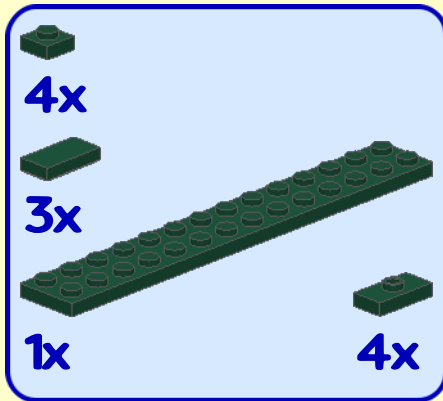

4

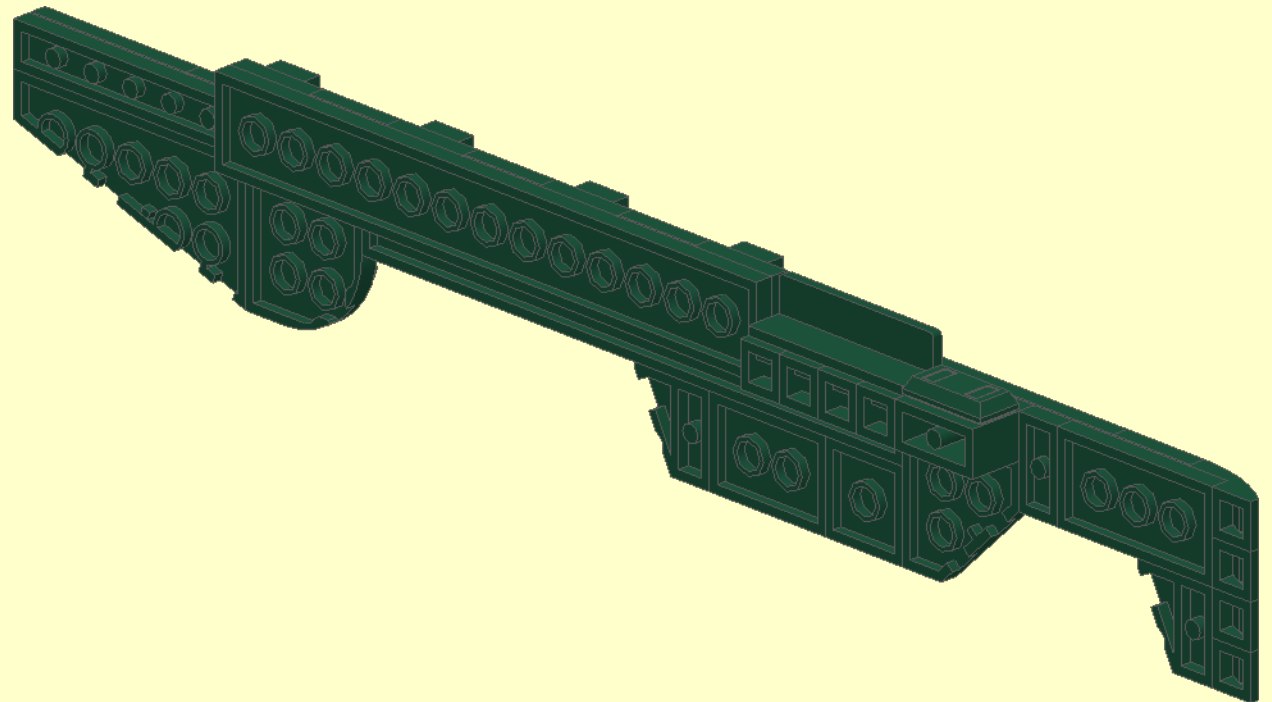
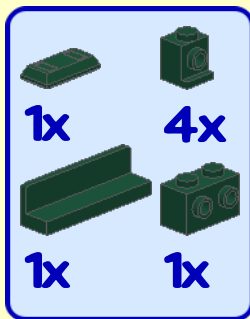

5

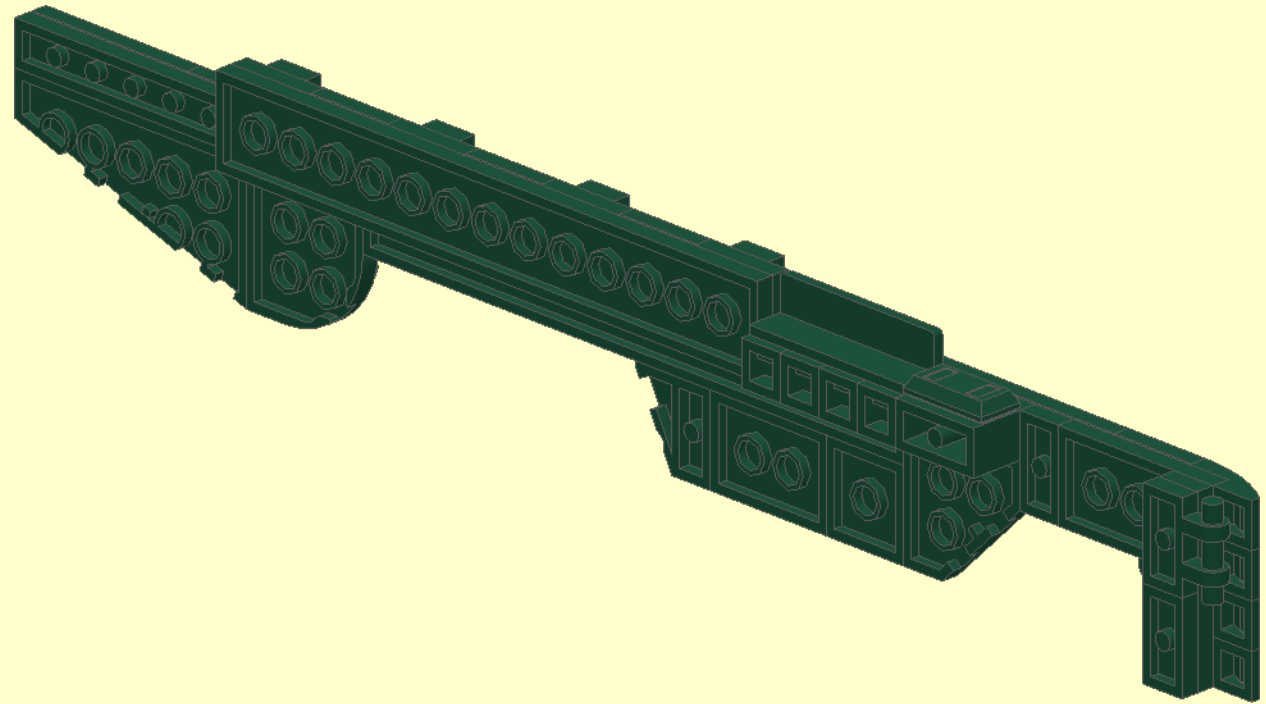
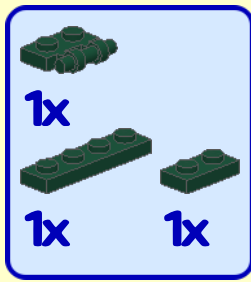

6

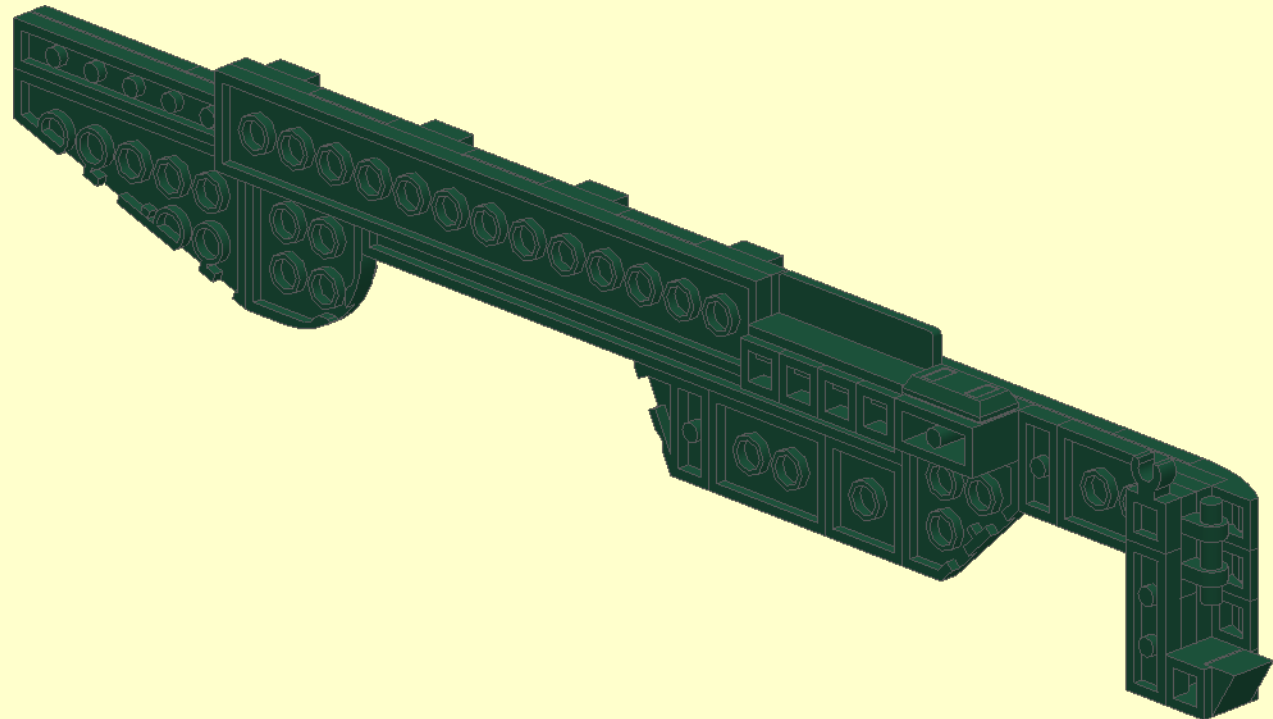
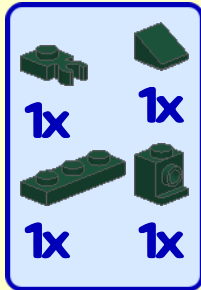

7

1x
1x 2x 1x

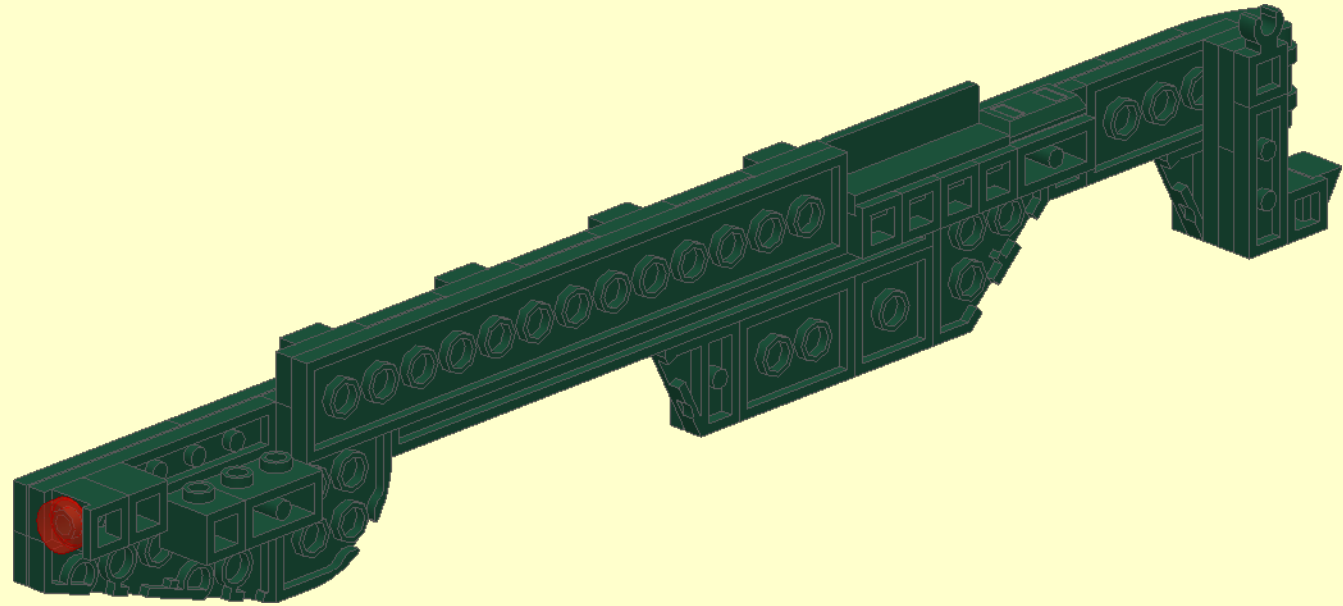

8

2x
2x

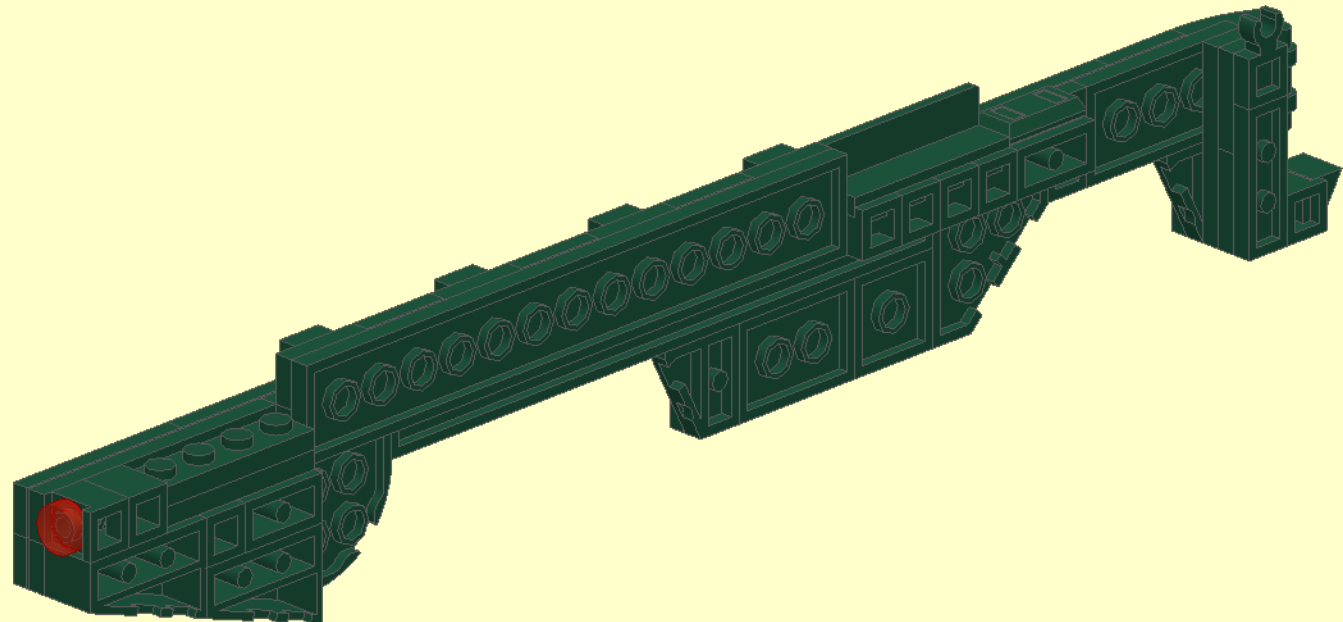

9

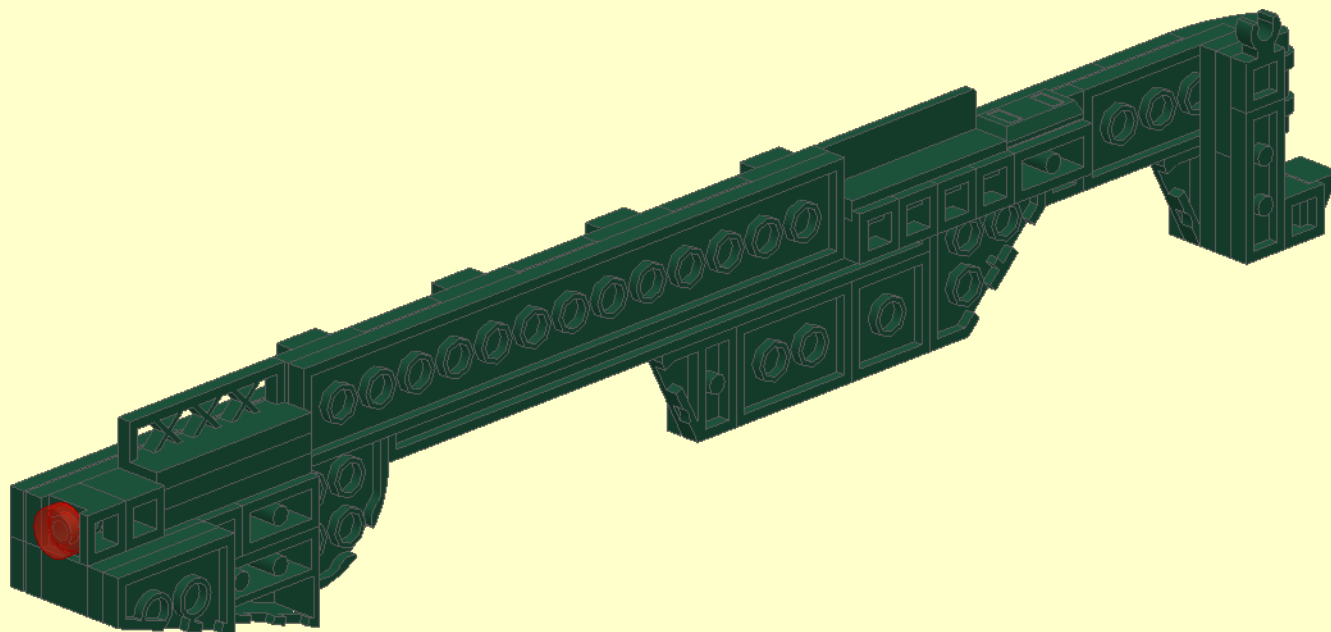
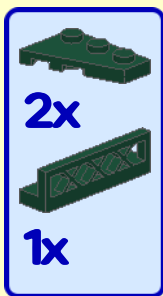

10

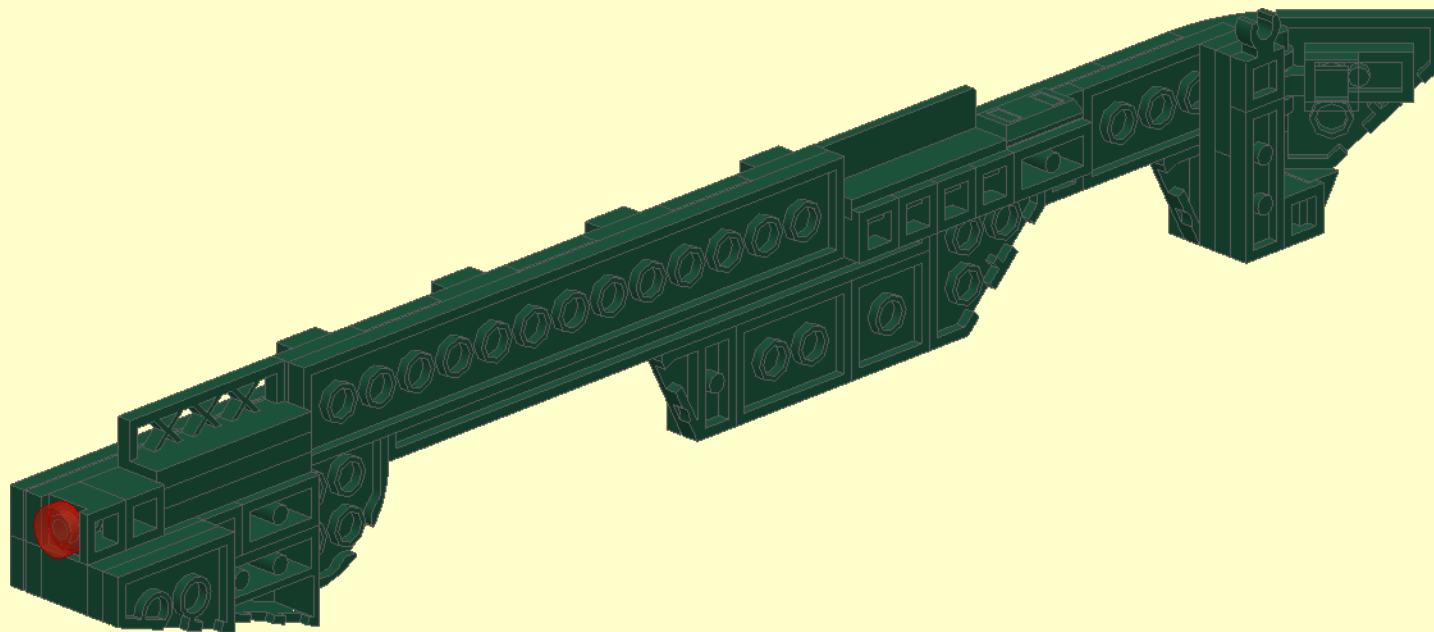
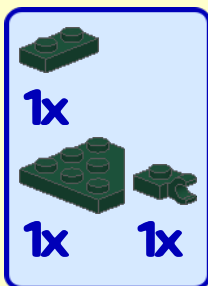

11

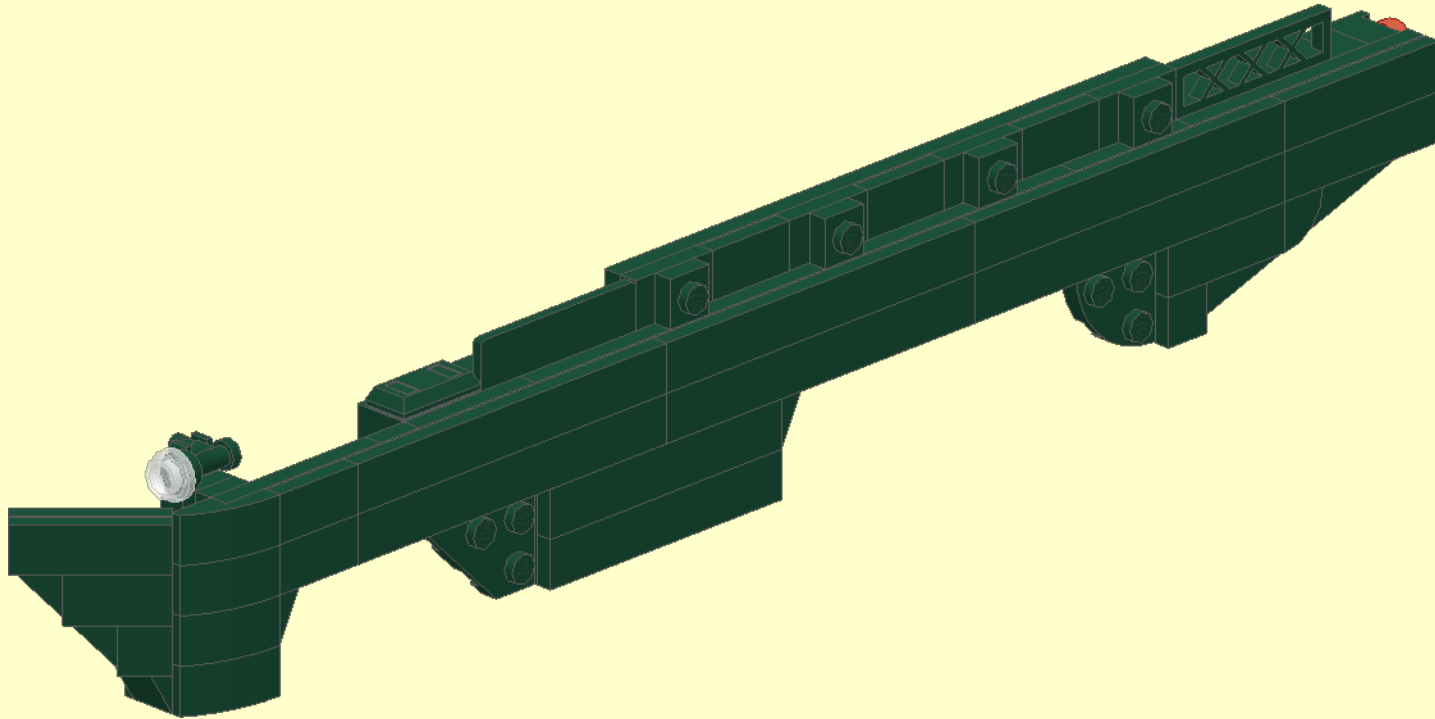
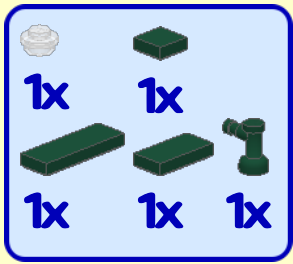

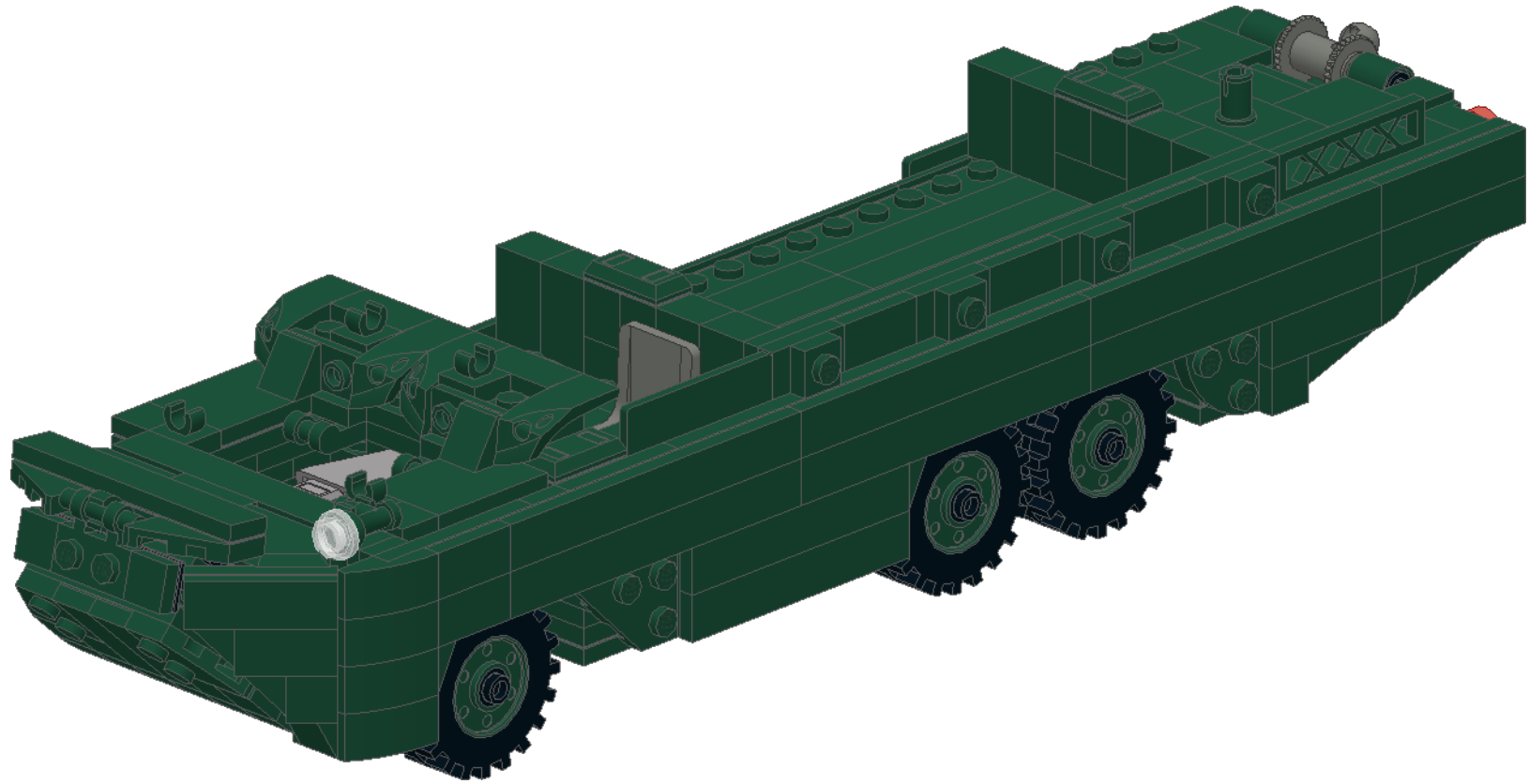

3

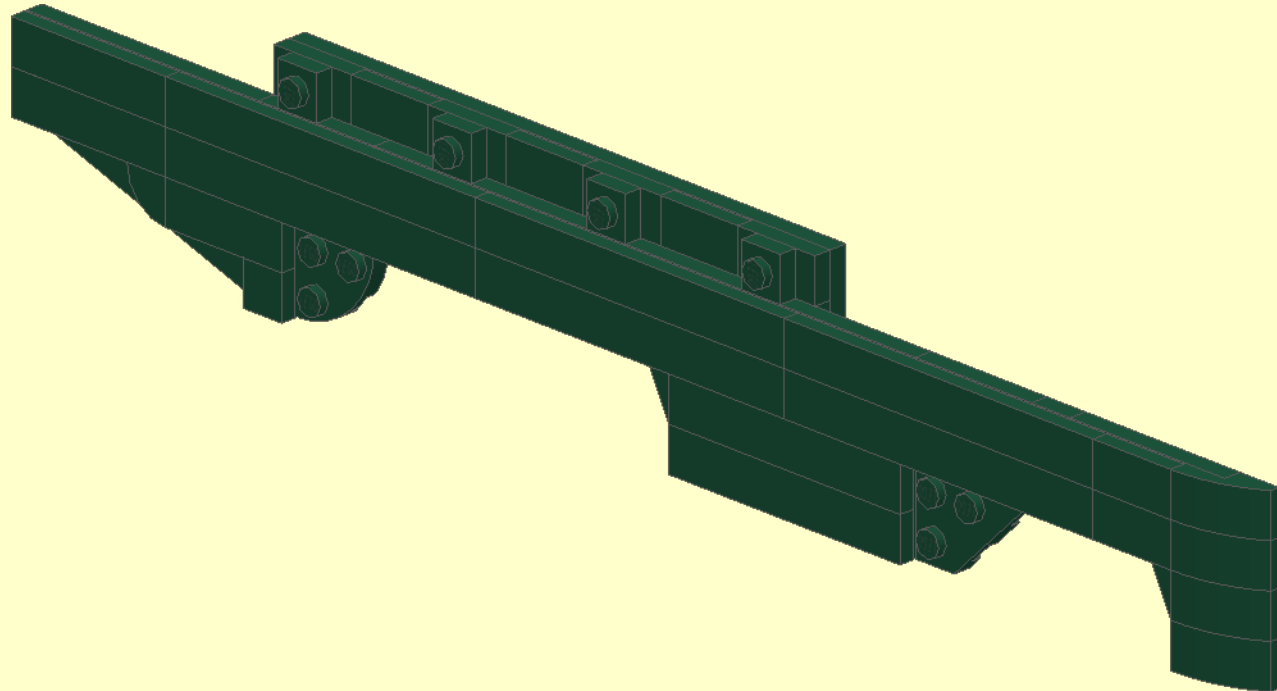
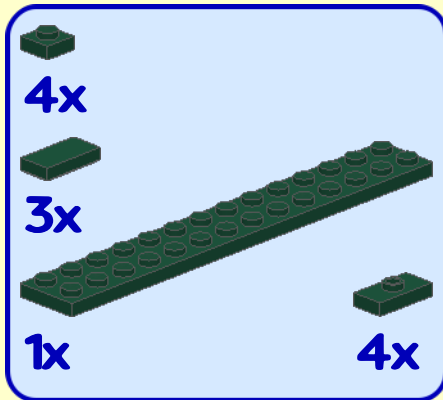

4

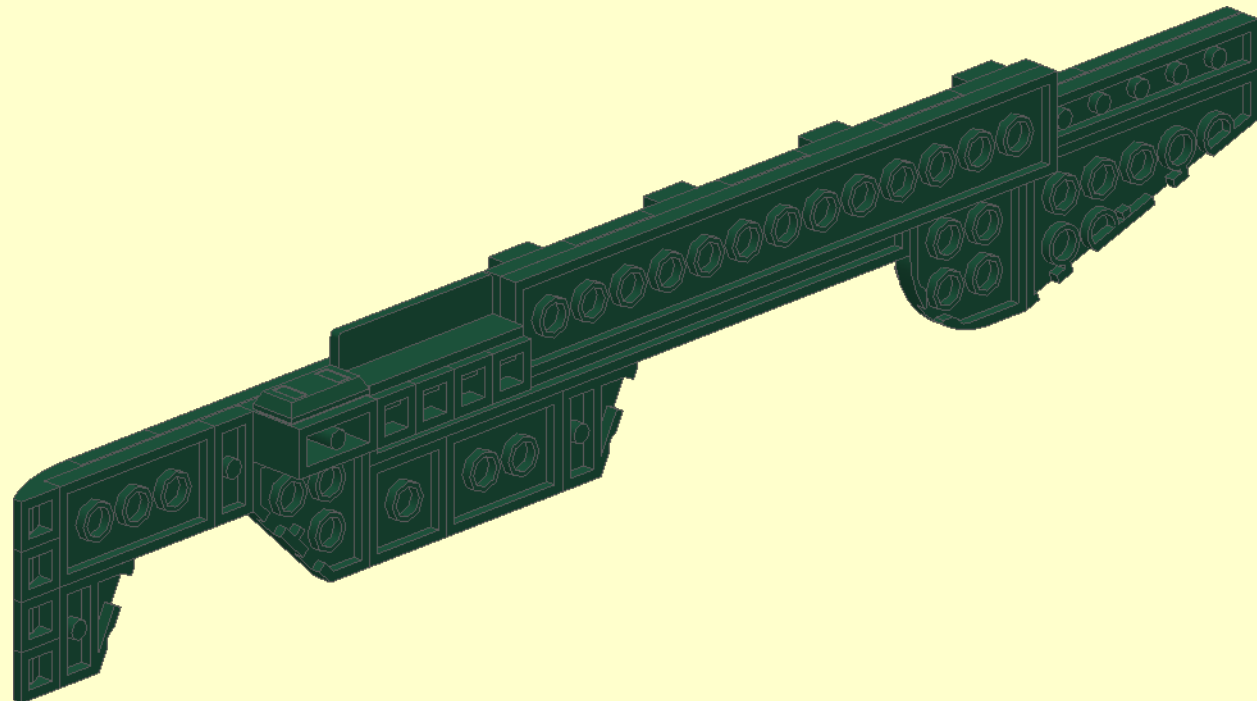
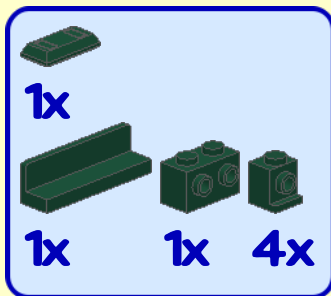

5

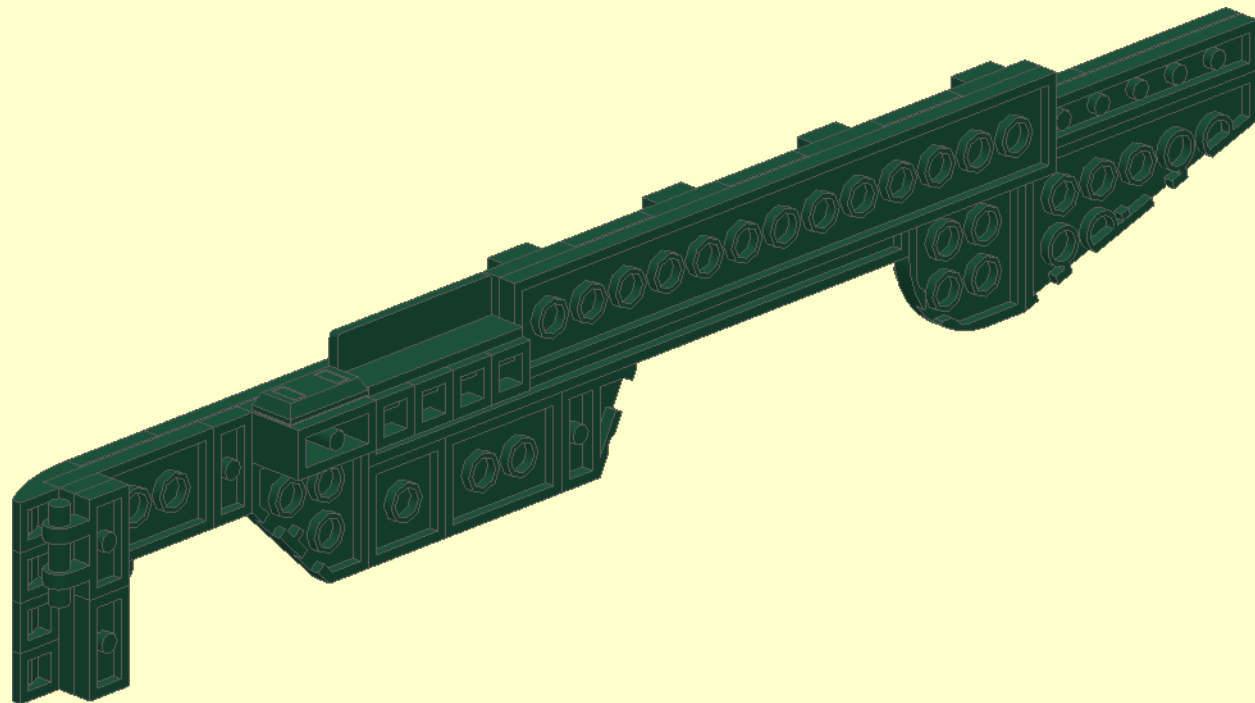
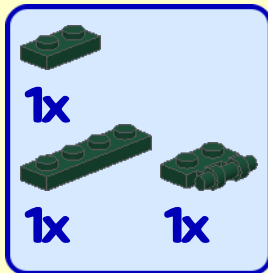

6

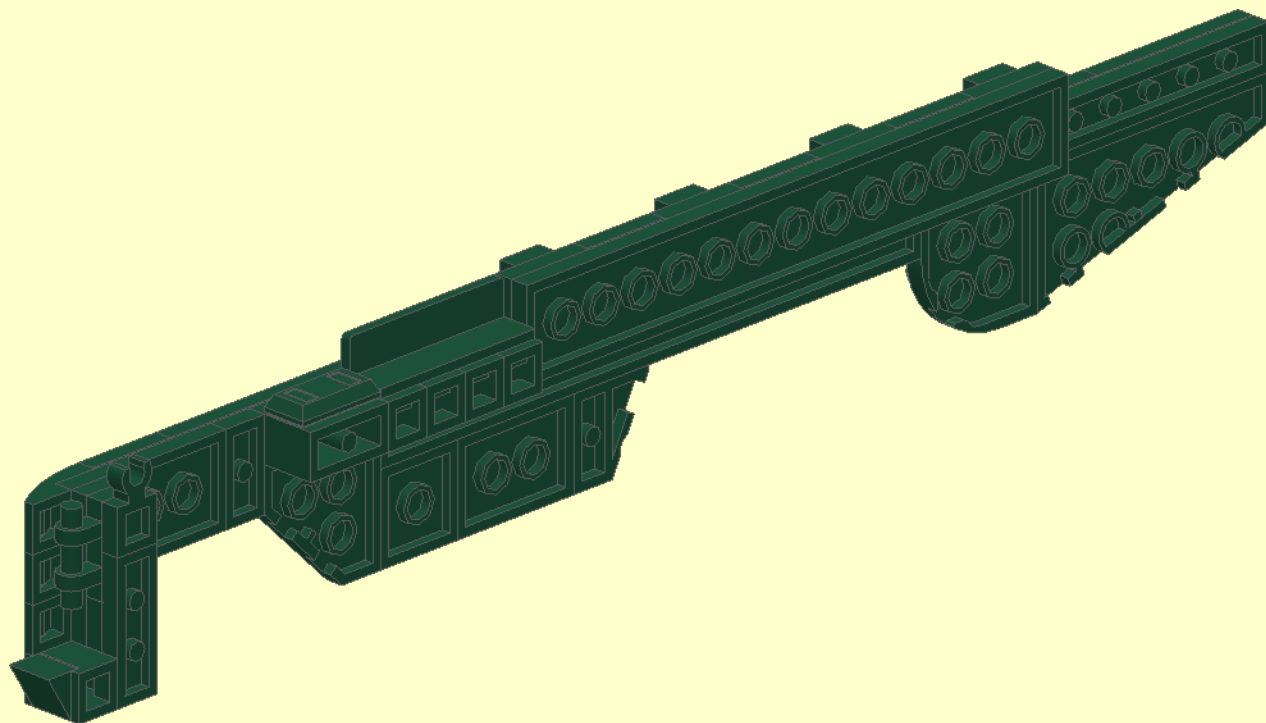
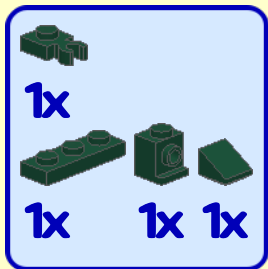

7

1x
1x 2x 1x

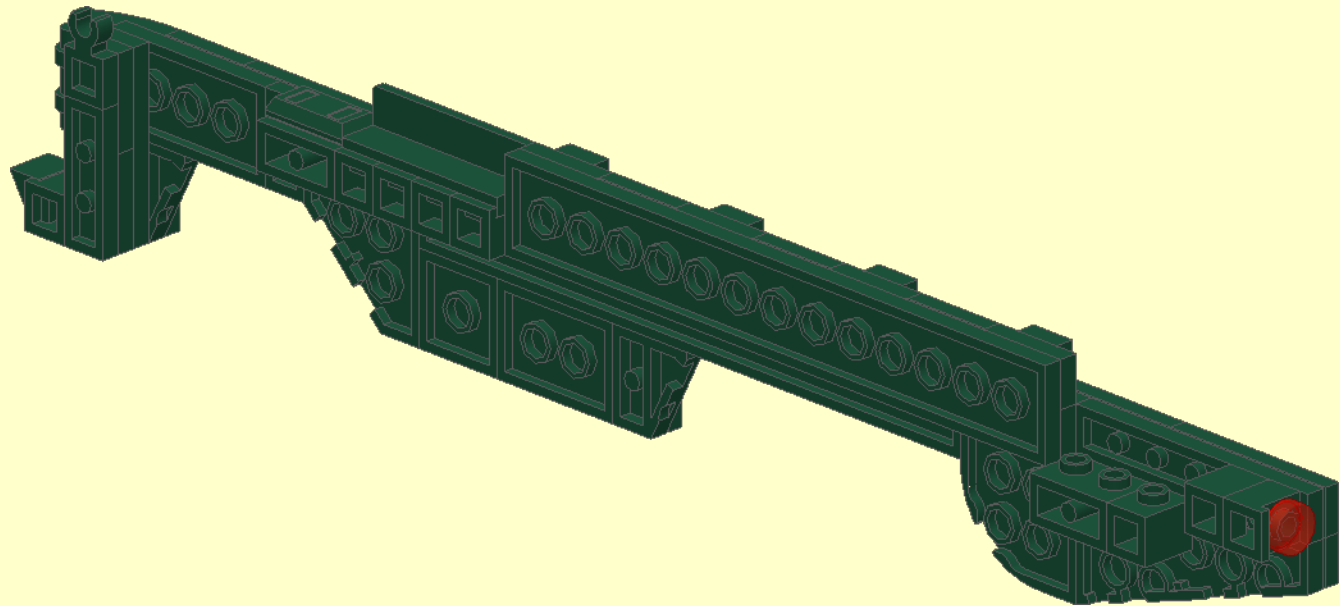

8

2x
2x

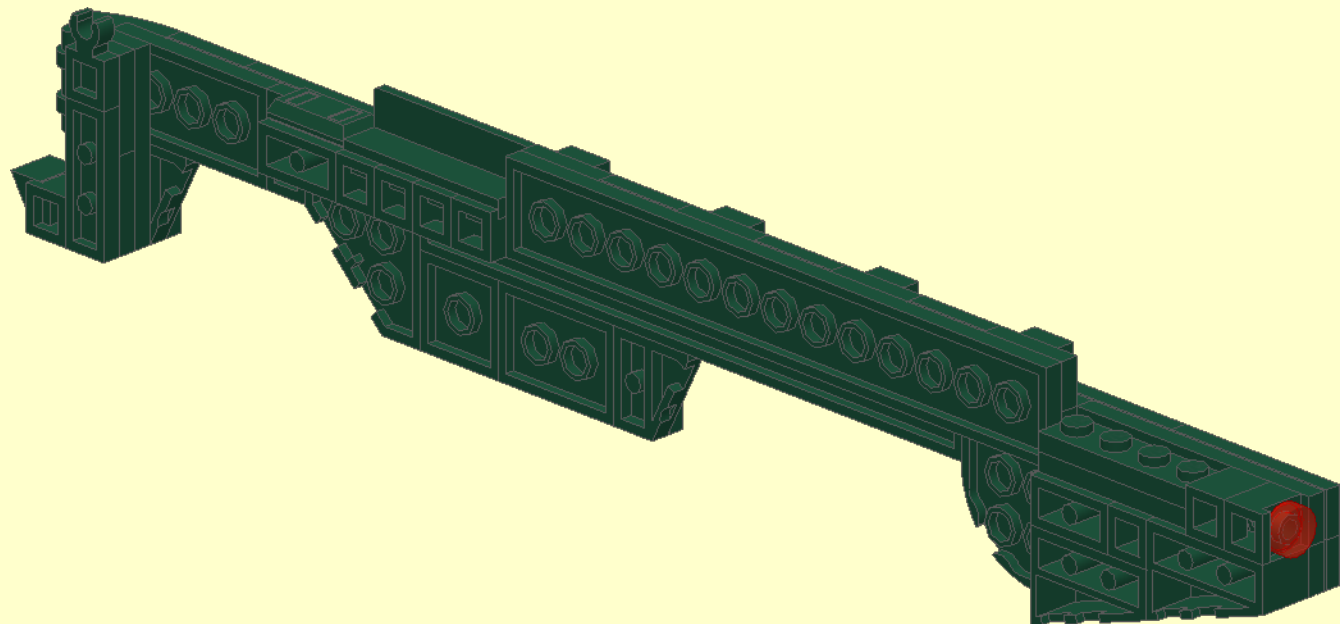



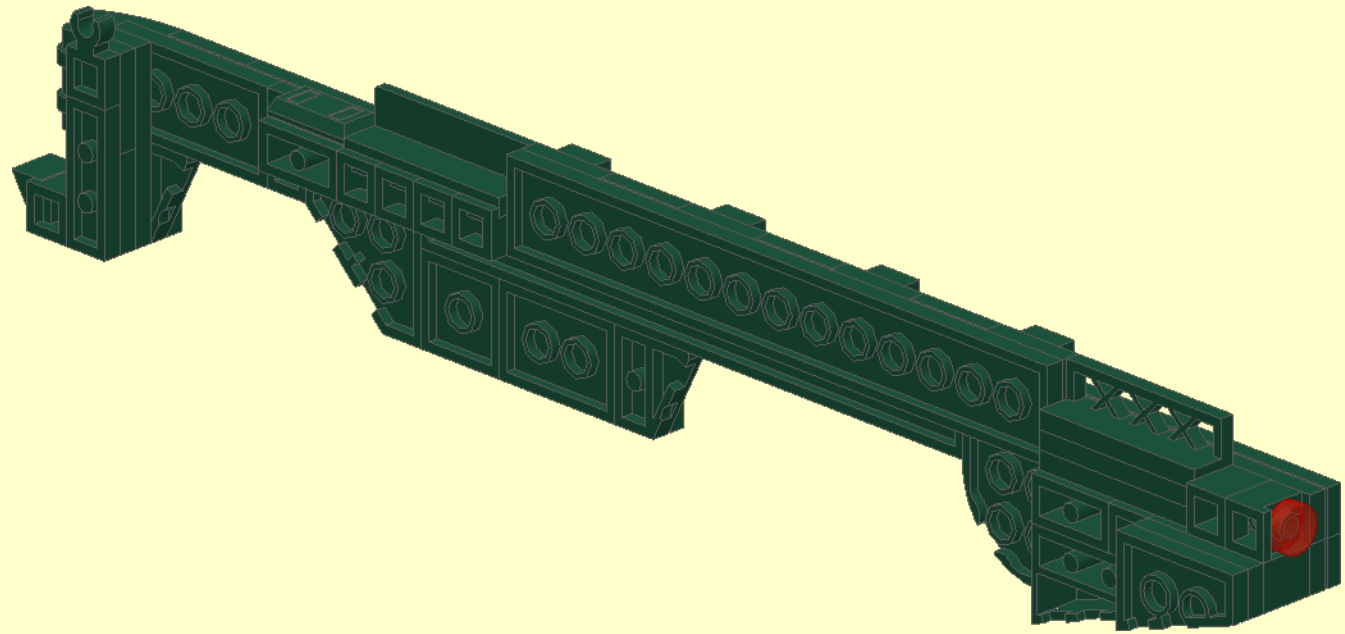
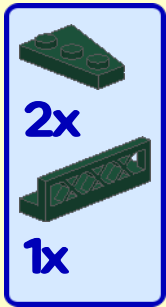

9

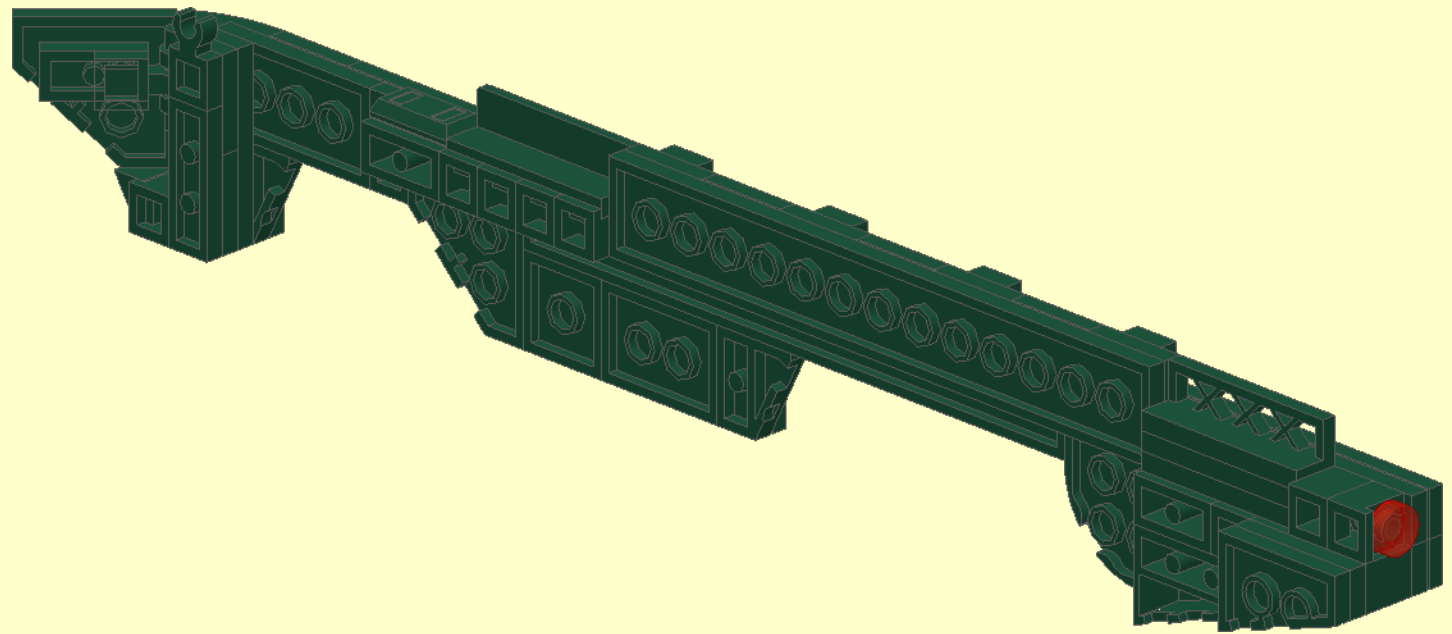
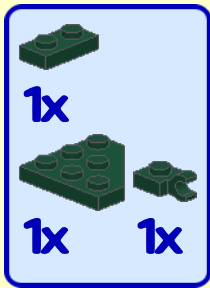

10



11

		
1x	1x	
		
1x	1x	1x

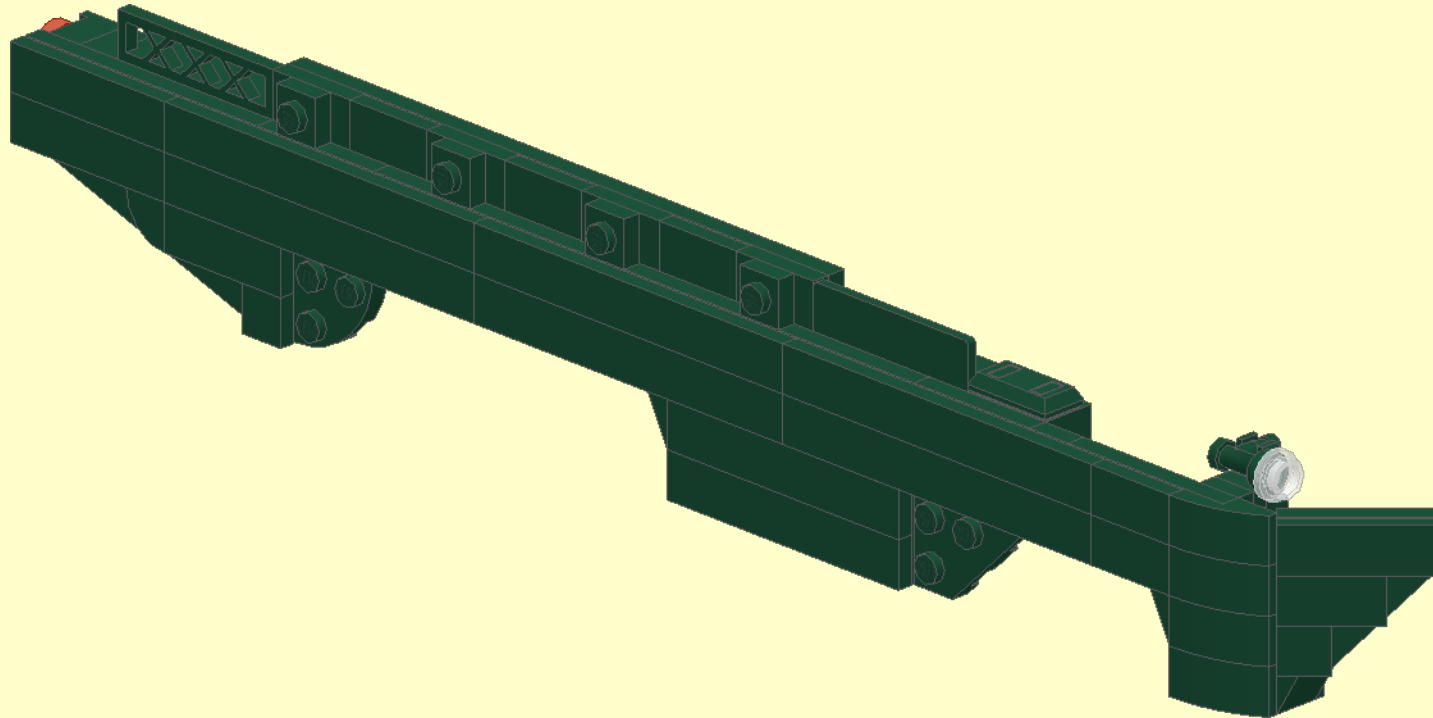

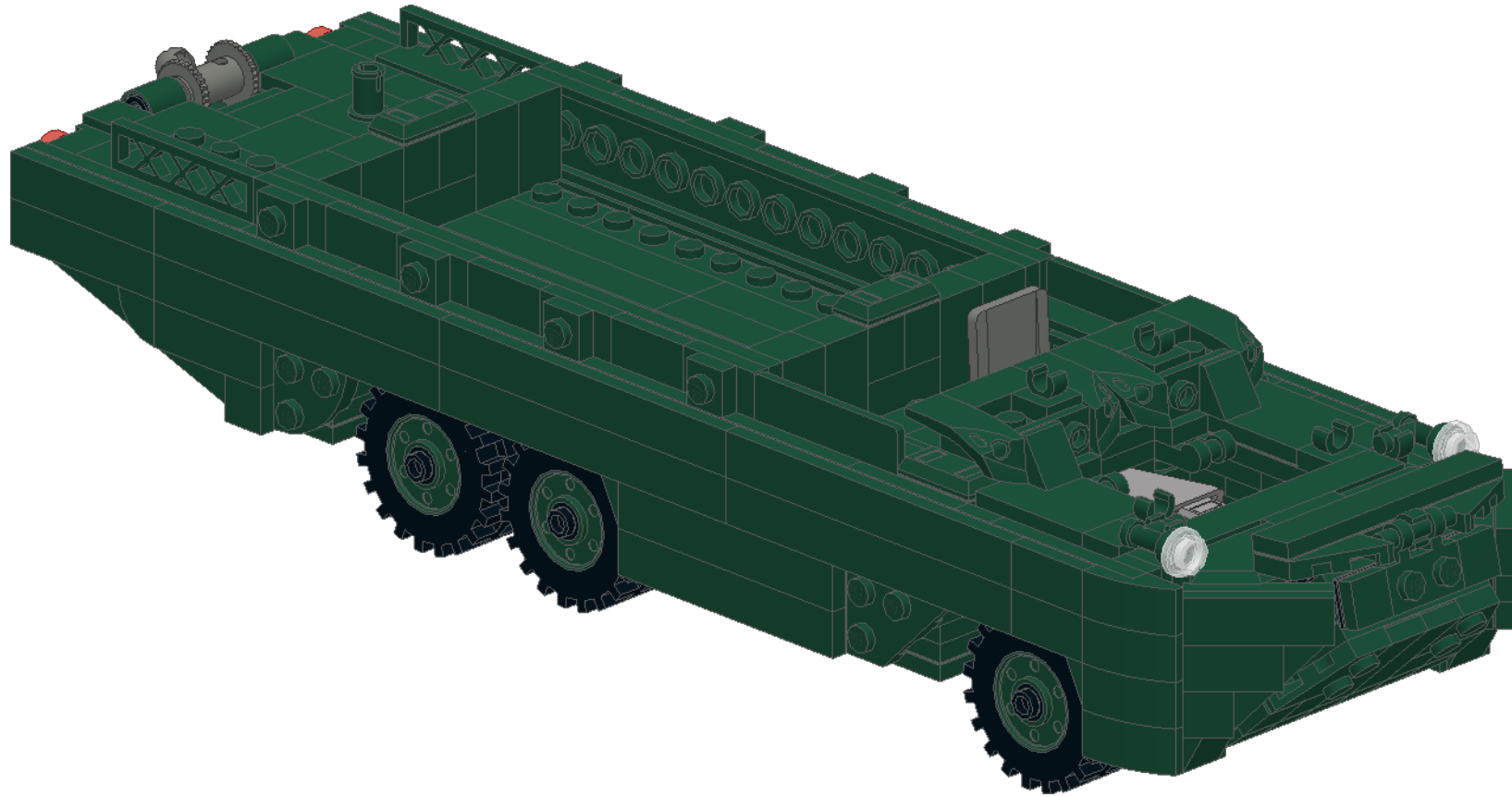

1

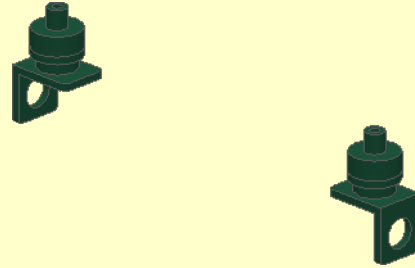
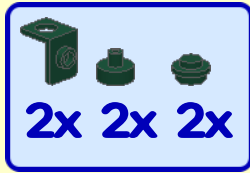

2

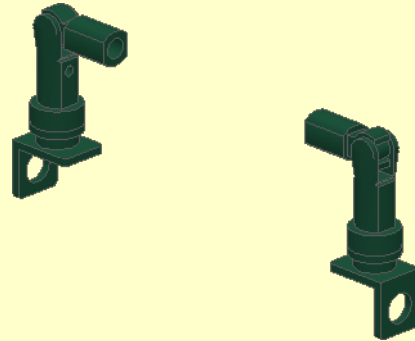
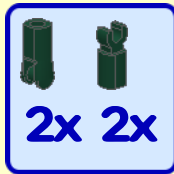

3

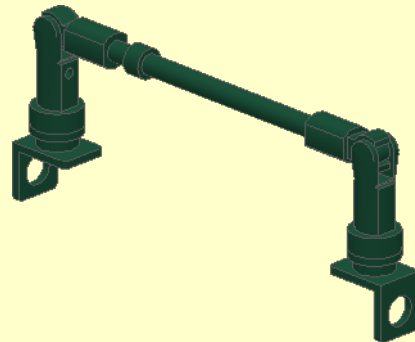
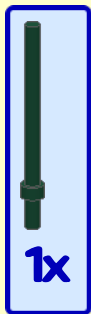

36

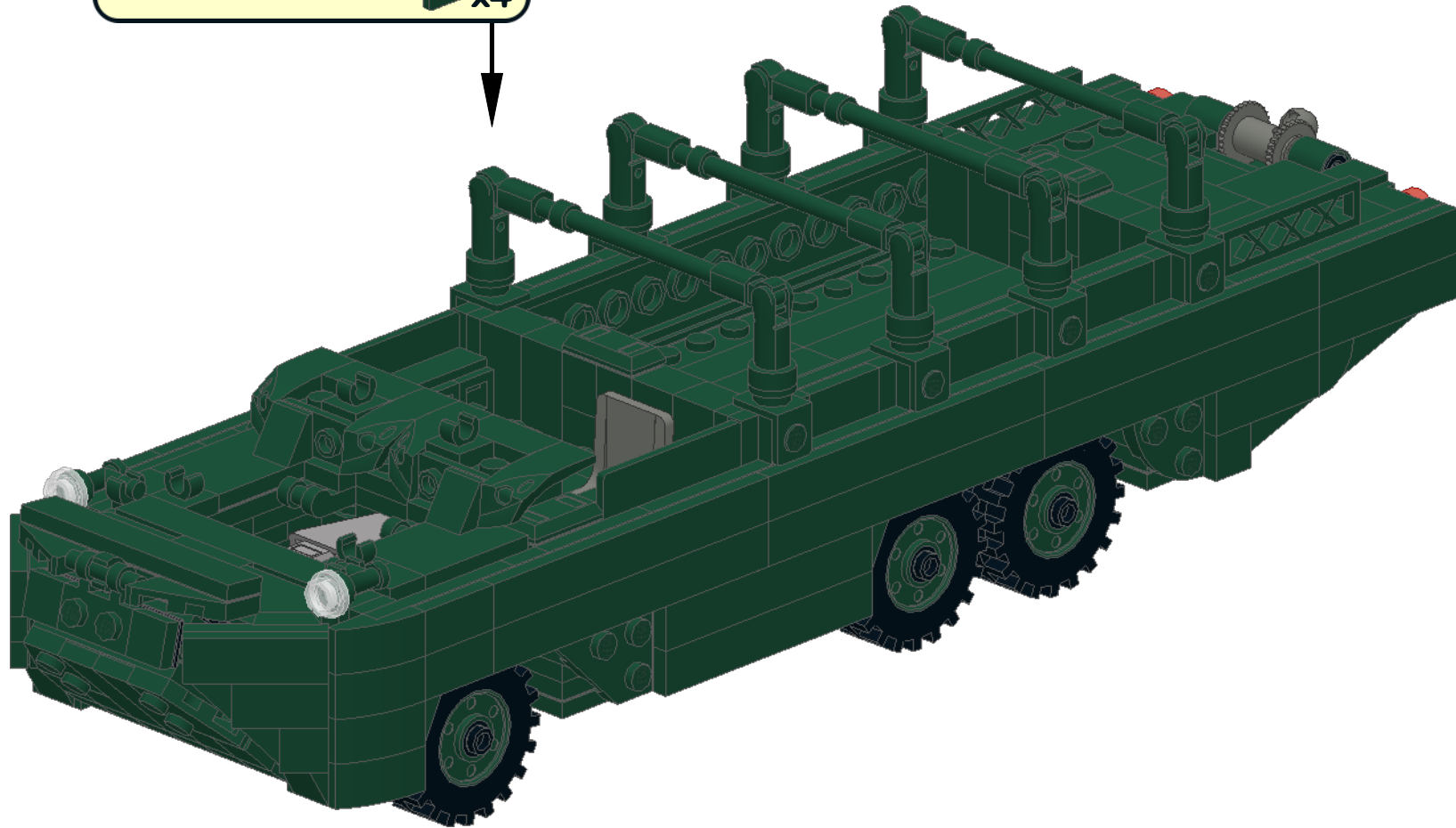
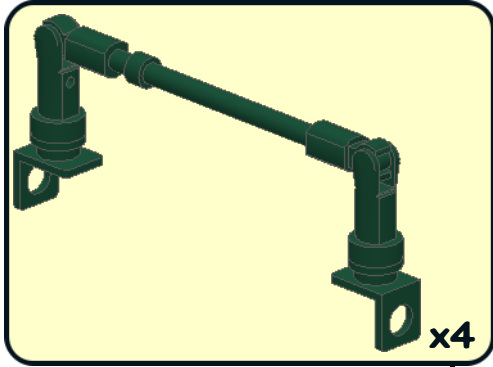

1

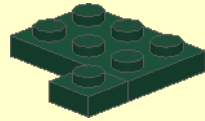
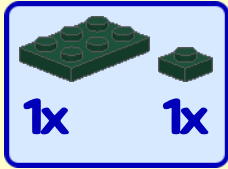

2

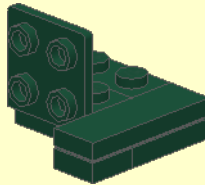
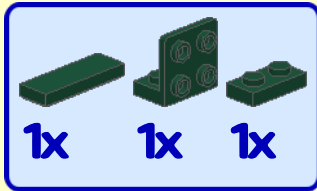

3

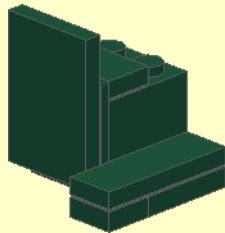
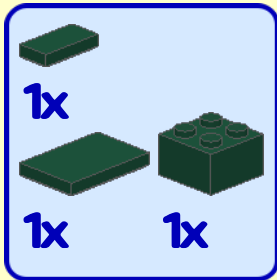

4

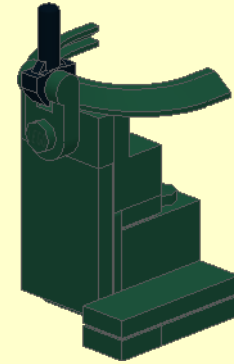
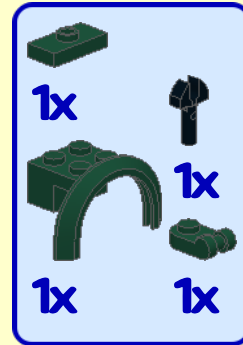

5

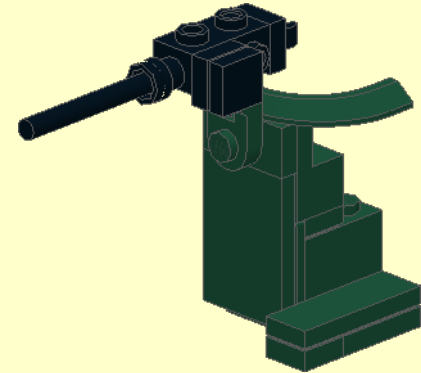
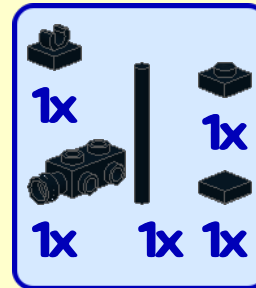

37

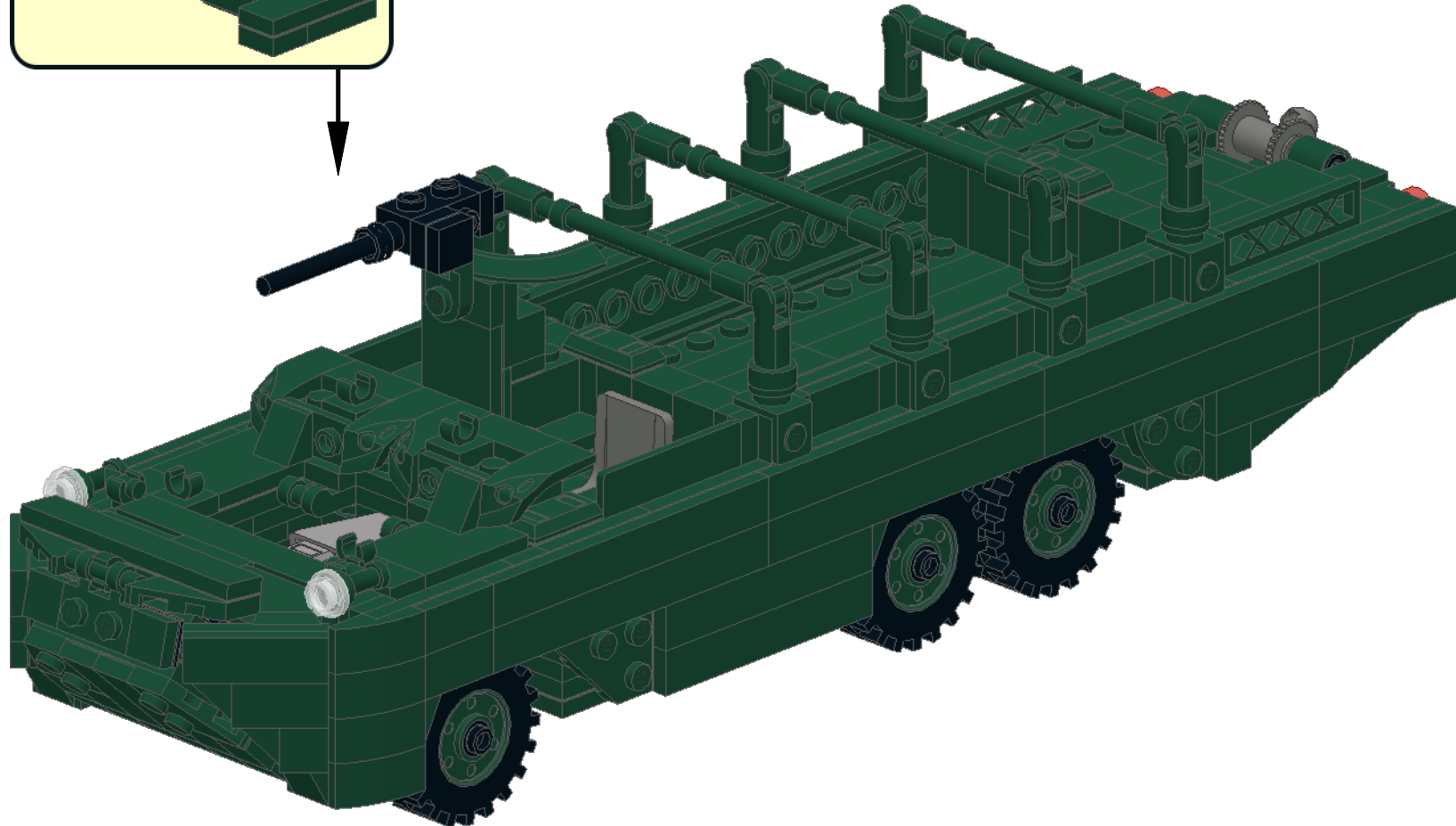
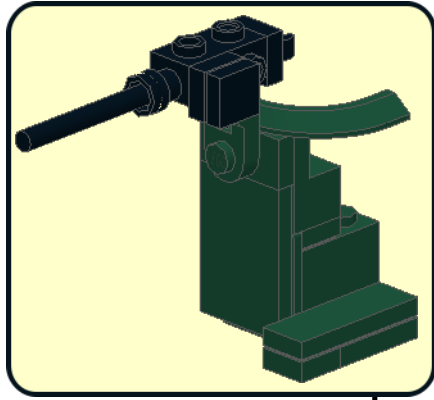

38

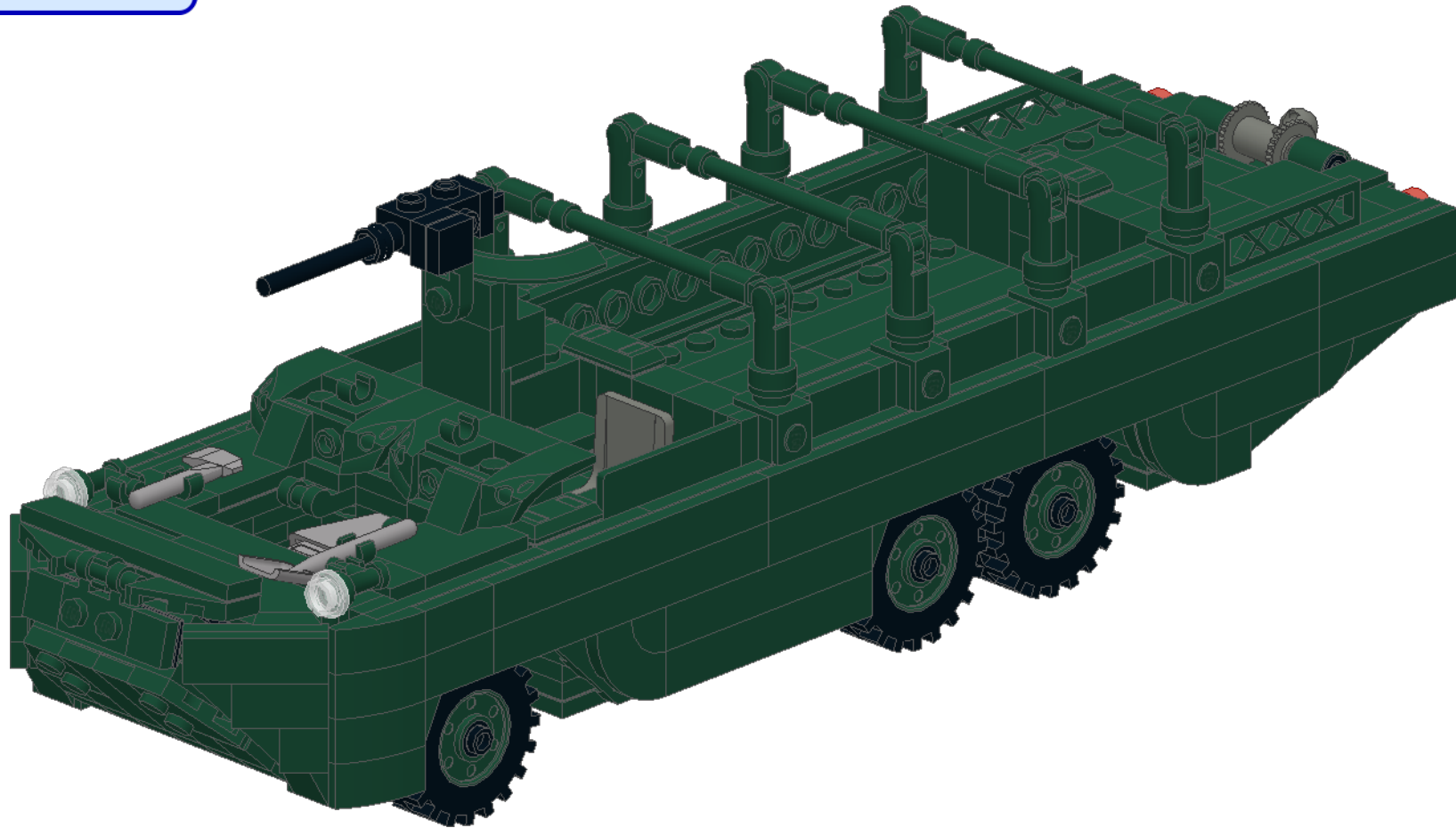
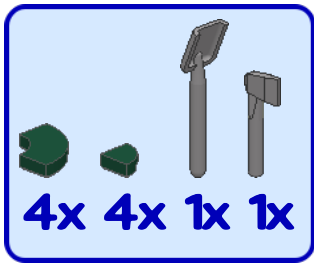

39

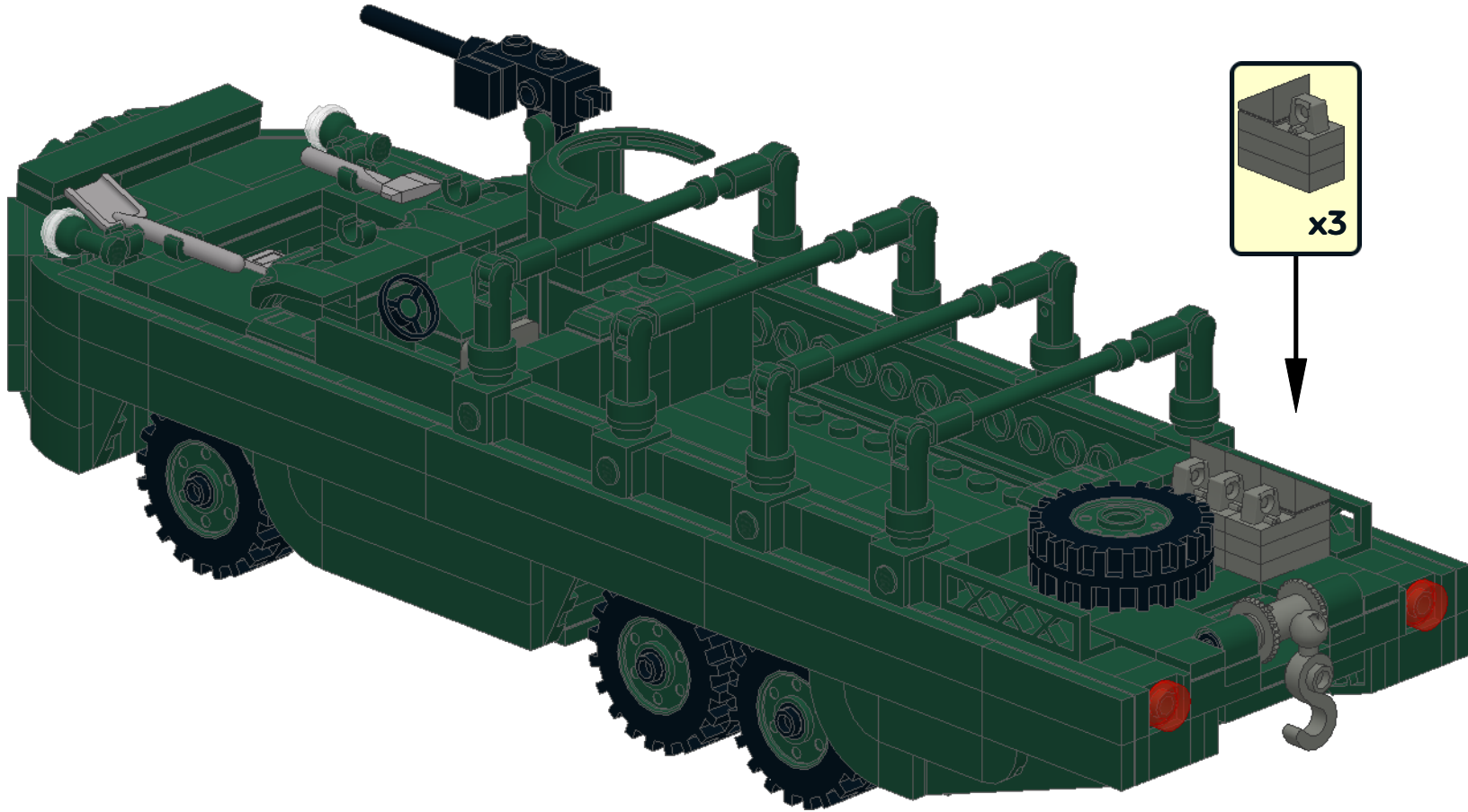
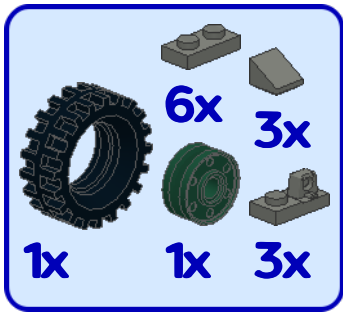

1

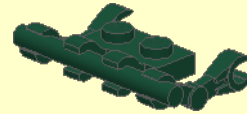
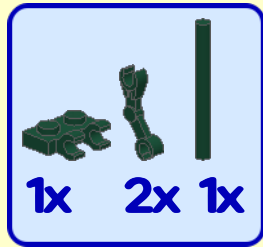

2

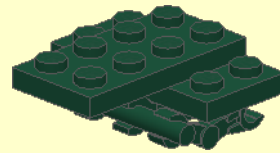
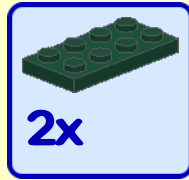

3

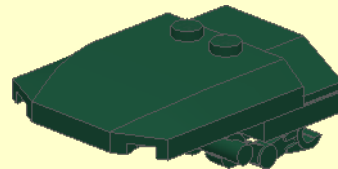
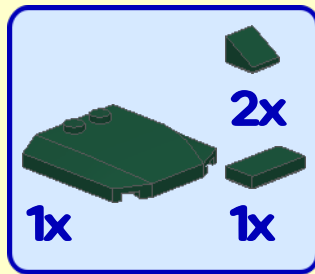

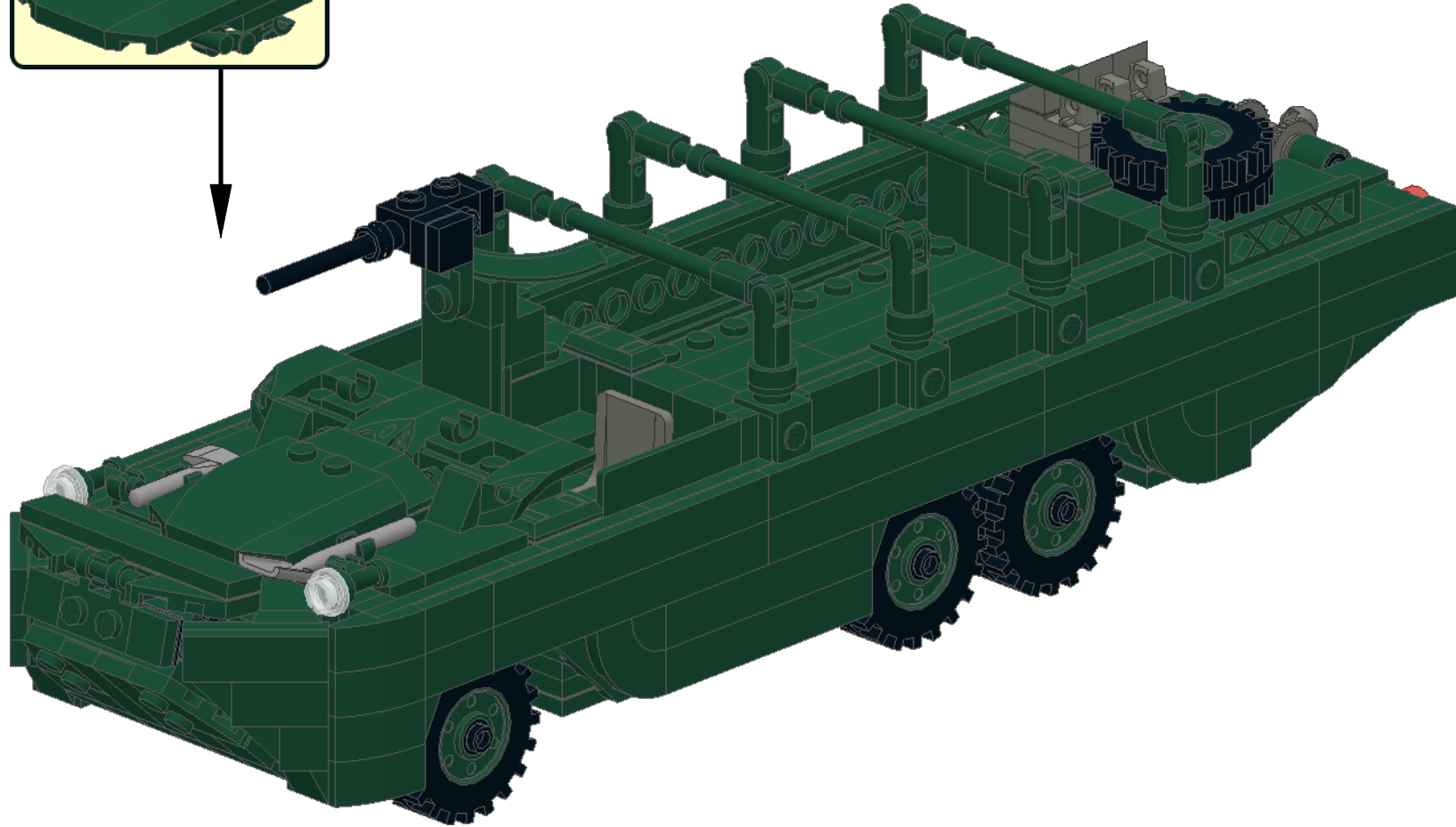
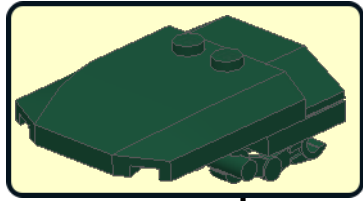

41

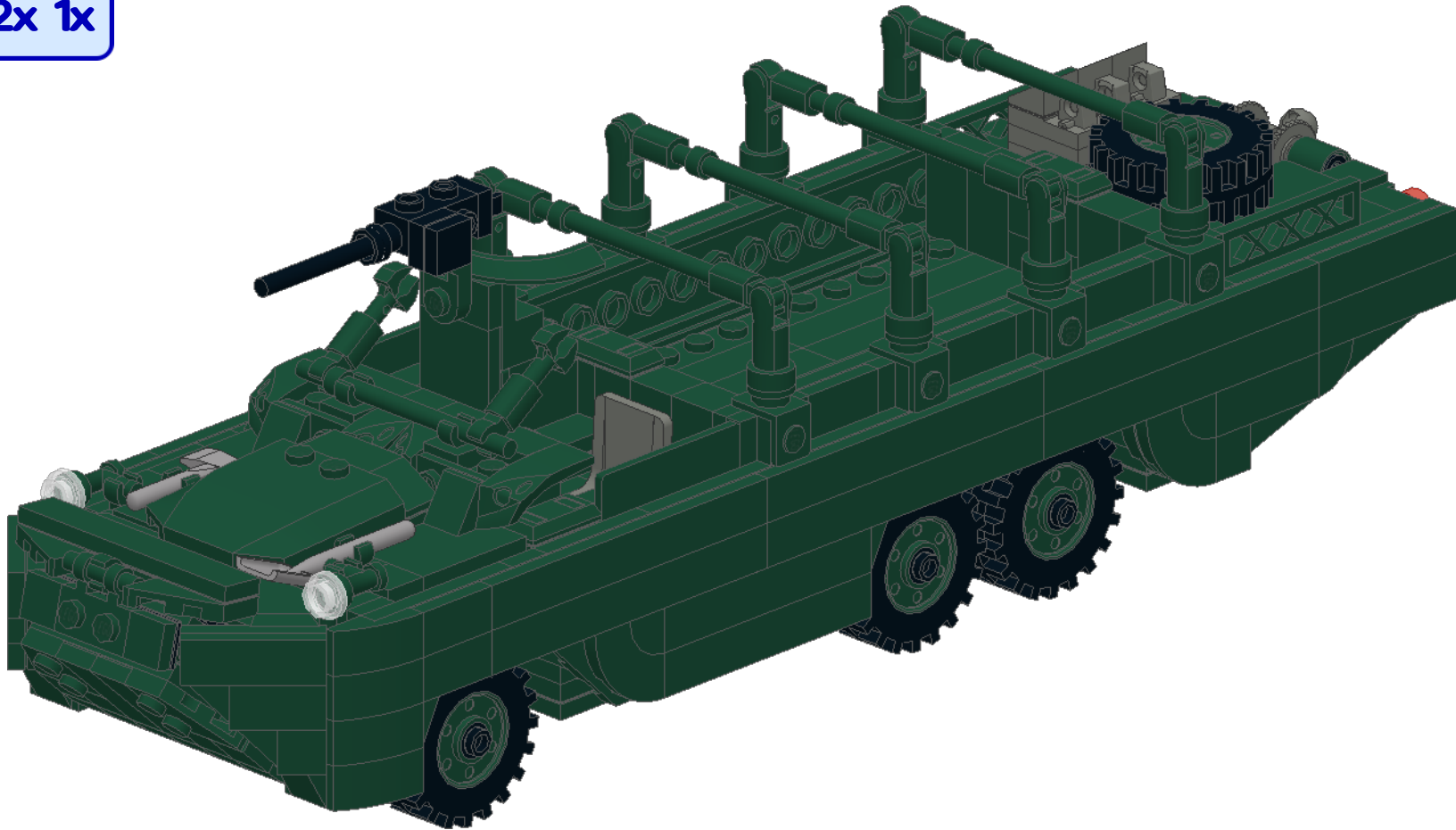
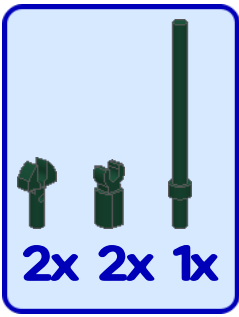

42

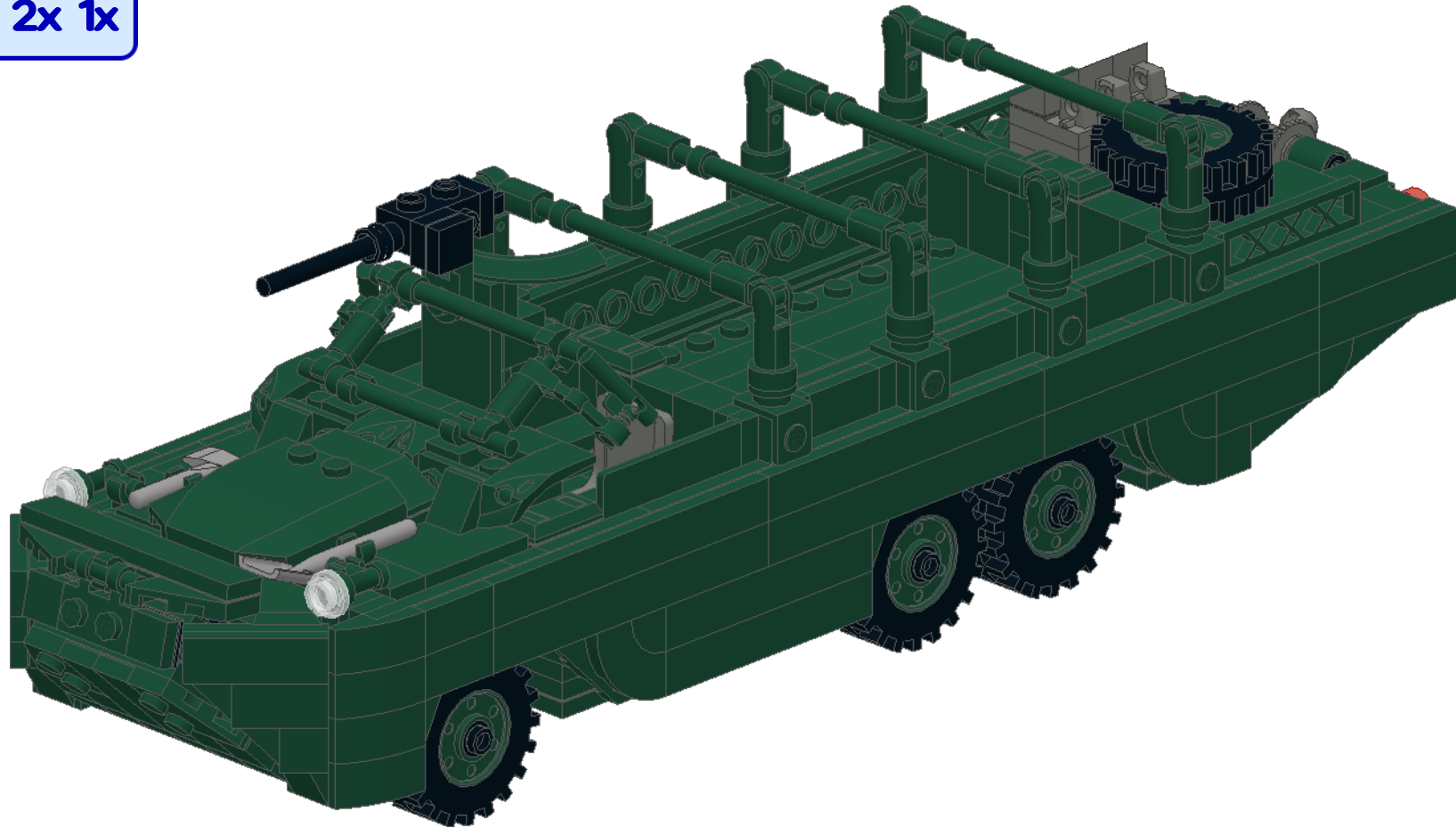
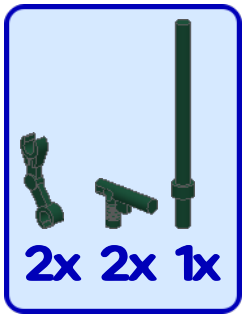

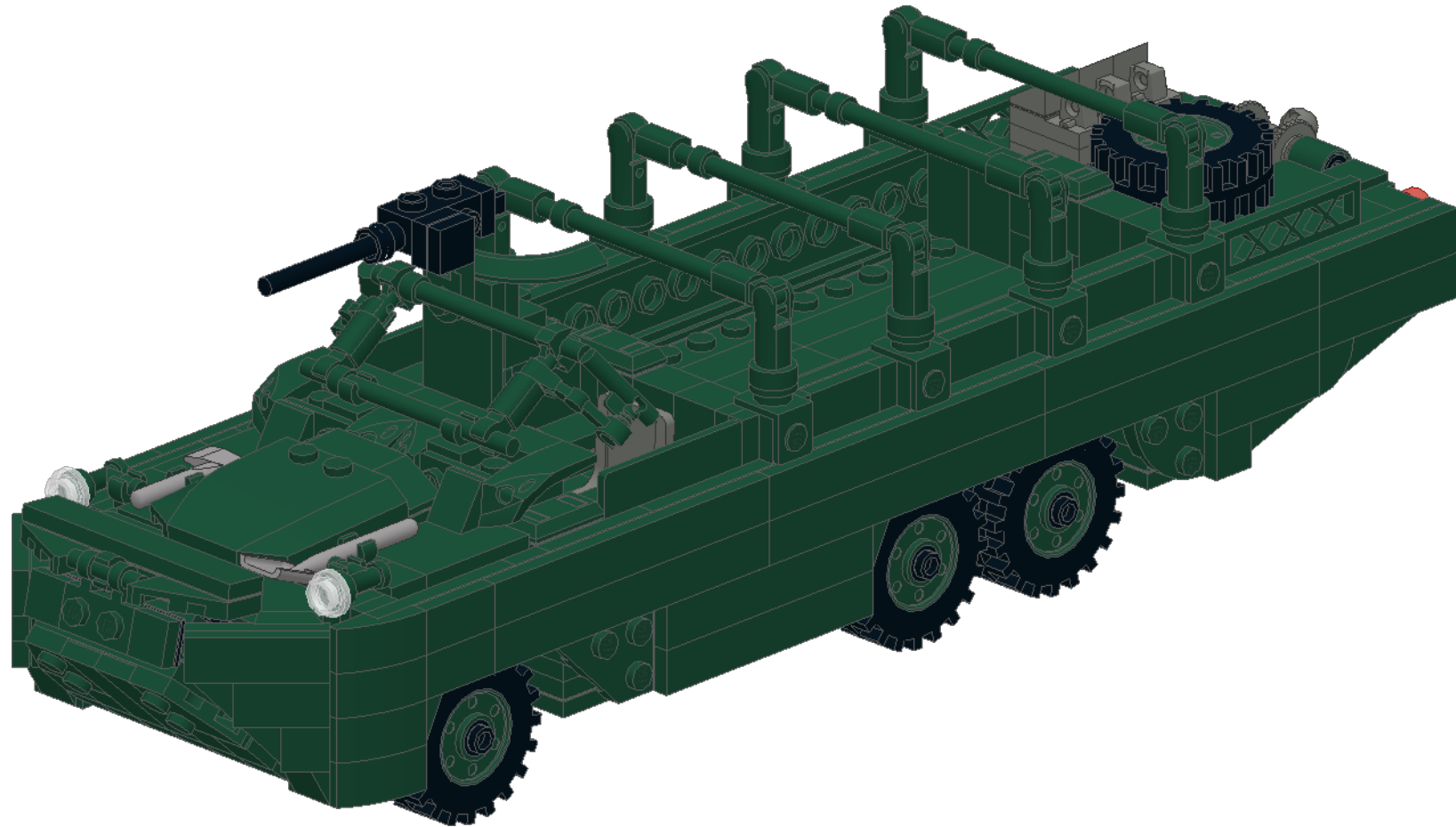

1

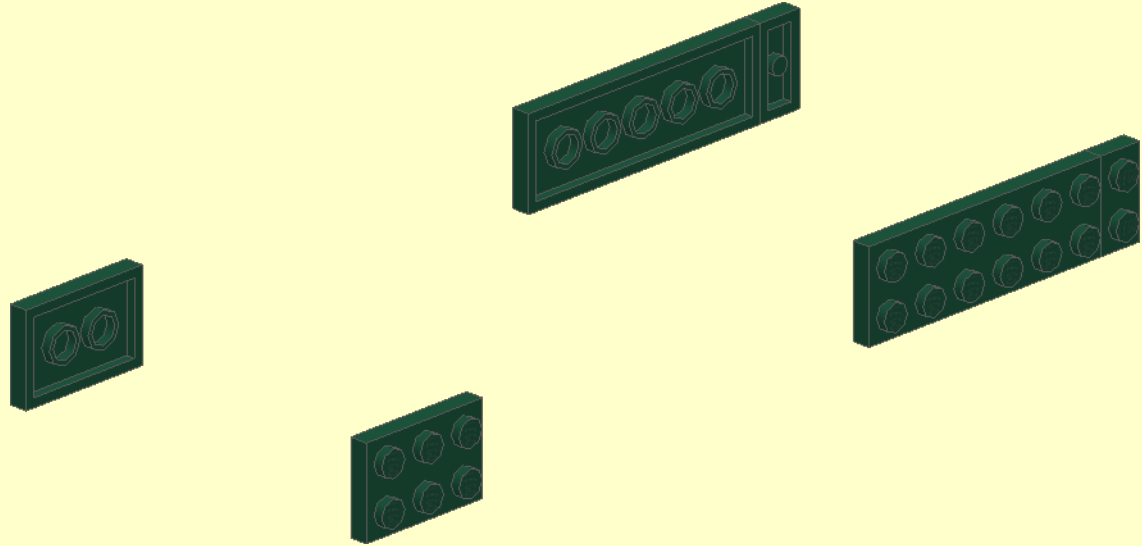
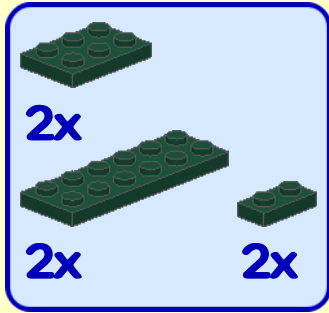

2

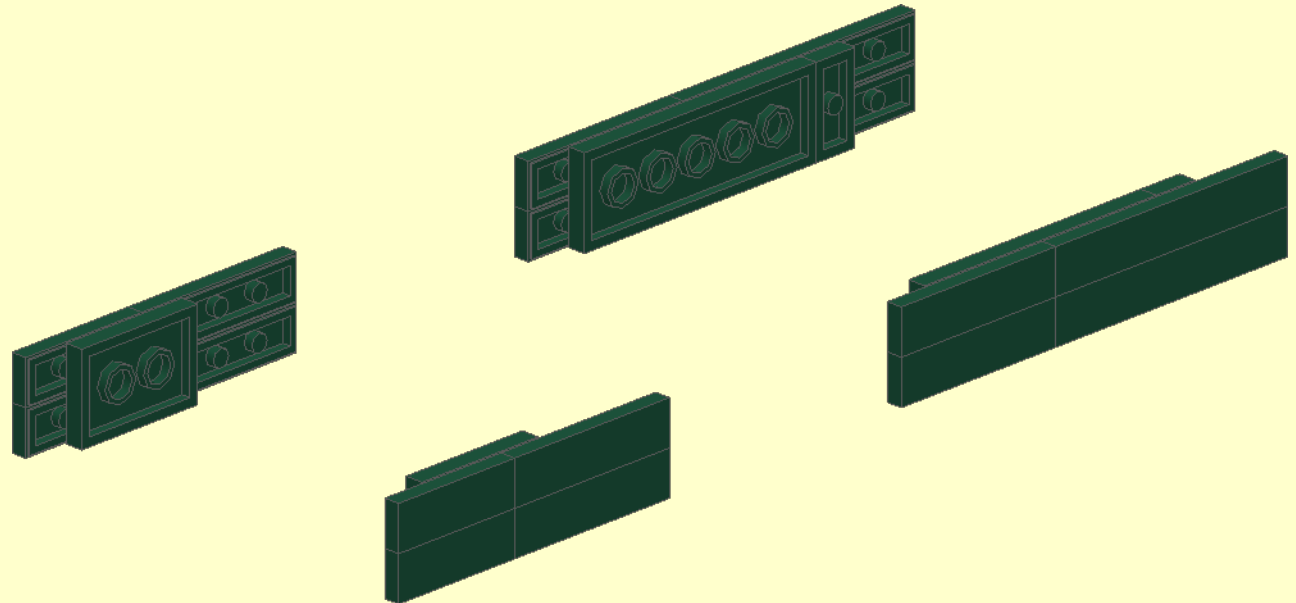
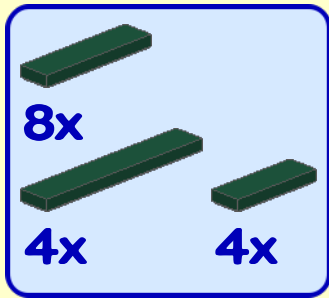

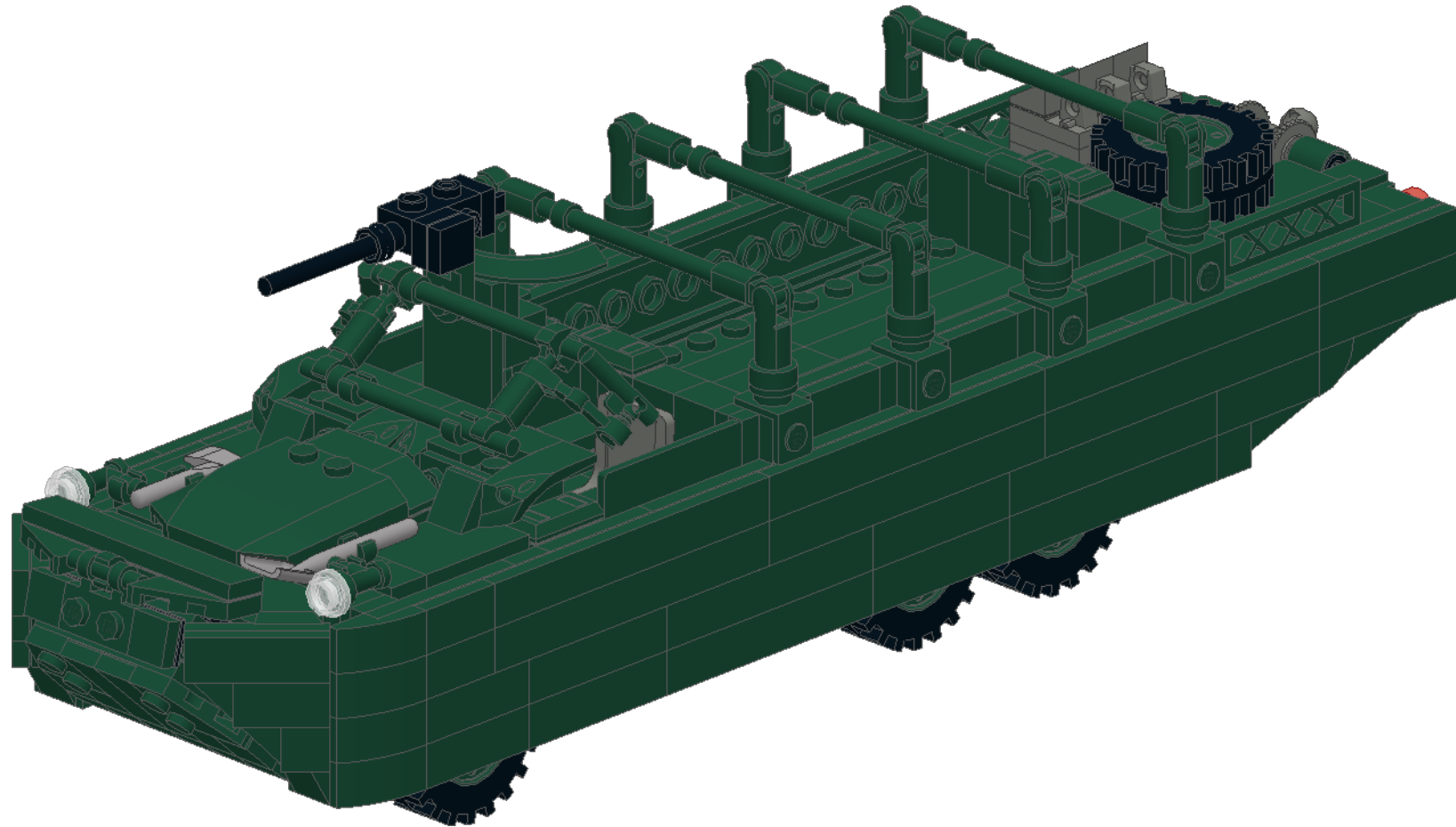

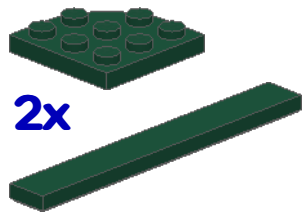

2x

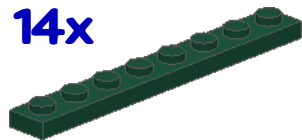

14x

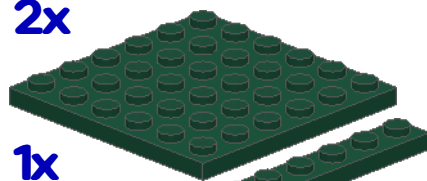

2x

1x

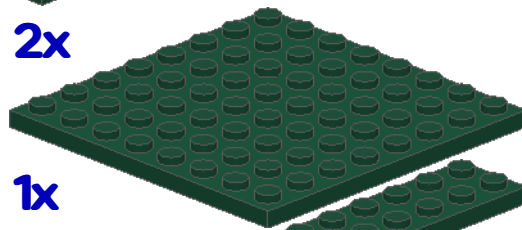

2x

1x

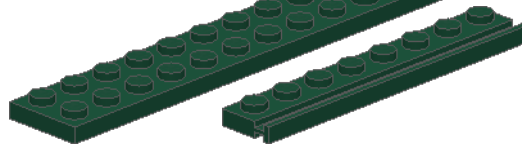

5x

2x

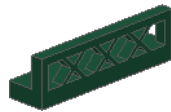

2x

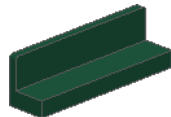

2x



1x

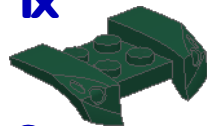

2x



1x



6x

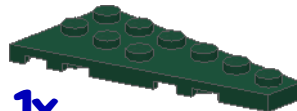

1x

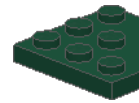

4x



1x

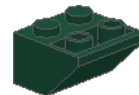

1x

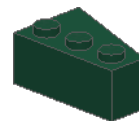

2x

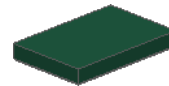

3x



2x



16x



1x



4x



4x

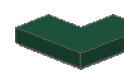

1x

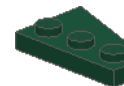

2x

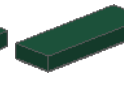

11x

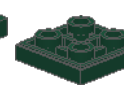

12x

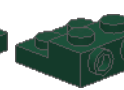

2x



9x



1x



1x

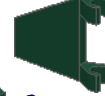

1x

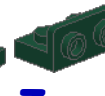

3x



12x

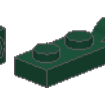

2x



6x

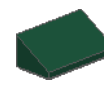

5x

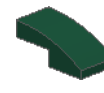

14x



2x



2x



6x



1x



16x



1x

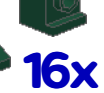

16x



10x



6x



1x



16x



6x



8x



8x



4x



4x



2x



2x



1x



1x



6x



2x



4x



2x



6x

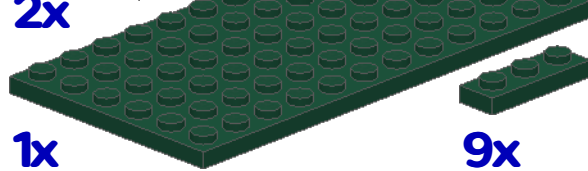
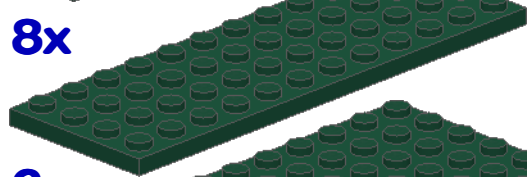
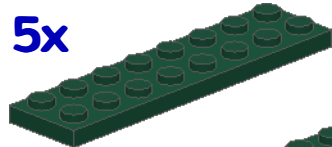
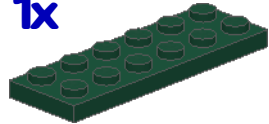
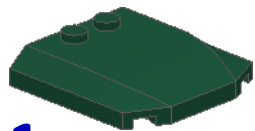
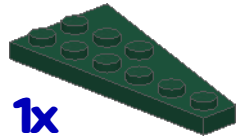

1x

9x

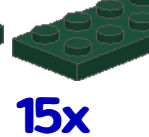
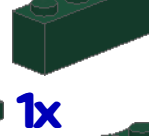
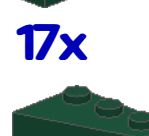
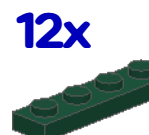
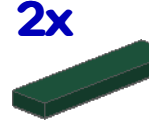
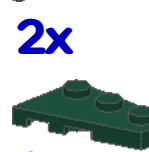

15x

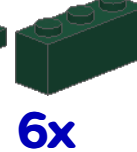
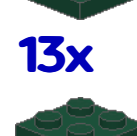
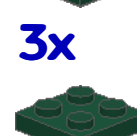
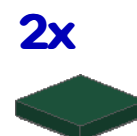
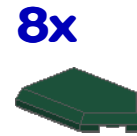
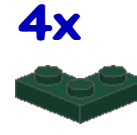
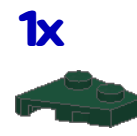

6x

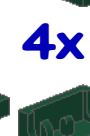
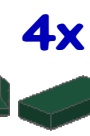

3x

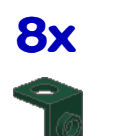
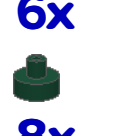
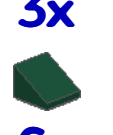
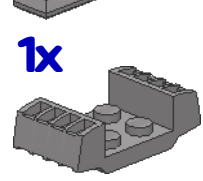

4x



1x

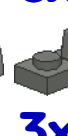

3x

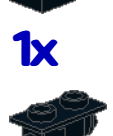

7x



2x